

Product Catalogue for **BLÜCHER® Channel**

High-Capacity Channels and Kitchen Channels



BLÜCHER®

A WATTS Brand



Safe solutions

BLÜCHER® stainless steel drainage products are installed in almost any kind of construction project, from multi-storey apartments and food processing factories to hospitals and on board prestigious cruise liners. We have specialised our competencies within four main segments:

Housing

Commercial

Industrial

Marine

The BLÜCHER® drainage system is a modular system providing numerous possible product combinations.

BLÜCHER® Drain

Floor drains for light- to heavy-duty flow and load applications.

BLÜCHER® Channel

Standard, modular or customised channels and kitchen channels for all flow and load applications.

BLÜCHER® EuroPipe

Push-fit drainage pipe-work system for soil, waste and rainwater.

Customised solutions

To ensure that any drainage requirement can be fulfilled we are always ready to solve your special request.

Strong products

All BLÜCHER® drainage products are produced in stainless steel grade AISI 304 or optionally grade AISI 316L. This material is ideally suitable for high-quality drainage systems:

- Fire resistant
- High strength - low weight
- Environmentally friendly

Furthermore it is corrosion resistant, resistant to impacts and thermal stress and requires little maintenance.

In the BLÜCHER® drainage products the inherent qualities of stainless steel are enhanced by careful product design resulting in:

- Long product life expectancy
- Excellent hygienic properties
- Easy installation
- Whole-life cost advantages
- Excellent flow capacities

All BLÜCHER® products are chemically descaled and passivated in order to enhance the natural corrosion resistance and provide a uniform matt-silver surface finish.

All stainless steel components are manufactured from recycled materials and are 100% recyclable.

Danish quality

Founded in Denmark in 1965, BLÜCHER has developed into a leading manufacturer of stainless steel drainage systems. Today, BLÜCHER is an international company with subsidiaries and representations worldwide. The BLÜCHER Group employs more than 350 staff worldwide.

Customers all over the World appreciate our know-how, dedicated service and common sense.

Through quality stainless steel products and drainage solutions that lead waste water away, BLÜCHER is committed to the promise of keeping up the flow.

The BLÜCHER® drainage products are manufactured in Denmark using the most modern production methods and in accordance with the internationally recognised quality standard ISO 9001. Furthermore, the most respected classification societies endorse the BLÜCHER® drainage products worldwide.



Selected references around the World

Hospitals, schools, commercial kitchens, the food and beverage industry and the pharmaceutical industry are among the customers that benefit from BLÜCHER stainless steel drainage systems.

Housing

BLÜCHER® stainless steel floor drains and pipe system are used all over the World in Scandinavian-style wet bathrooms in single and multi-storey buildings.

Commercial

Queen Mary Hospital, Hvidovre hospital, Princess Alexandra Hospital, Blackpool Victoria Hospital, Queen Elizabeth Hospital, St. James Hospital, University College London Hospital, Sportcentrum Fitness First, Czàsar Swimming Pool, Sports & Aquatic Centre, International Grammar School, Collège Bellevue, Elite University, Universitat Pompeu Fabra, Augustenborgskolan, Canadian International School, North Texas State University, Elderly Citizens Home Adelaide, Old Peoples Home Budapest, Maryland State Prison, Uppsala Polishus, Oslo Opera, Hilton Hotels, Hotel Marriot, Sofitel, Novotel, The Ritz Carlton Bahrain, McDonalds, Burger King, Pizza Hut, Le Louvre, Bahrain National Museum, Ministère de L'Industri, State Library of Victoria, Royal Danish Theatre, Copenhagen Zoo, Hong Kong Disneyland, Dubai Mall, IKEA, Tesco, Coop, Metro, Carrefour, Lidl, Woolworths, Gardamoen Oslo, Copenhagen Airport, Heathrow Airport, Barcelona Airport, New Athens Airport, Orly Airport, Arlanda Airport, Helsinki Airport.

Industrial

Pfizer, GSK, Astra Zeneca, Johnson & Johnson, Aventis, Kraft, Nestlé, Danish Crown, Daloon, Tulip, Knorr, Singapore Airport Catering, Ahlgreens, Estrella, Kelloggs, CocaCola, Pepsi, Heineken, Carlsberg, Whitbread Breweries, Budweiser, Tropicana Juice Processing, Absolut Vodka. Nestlé, Arla Food, Danone, Unilever, Almarai Dairy. Mercedes, Renault, L'Oreal, Sony, BASF, 3M, IBM World Headquarters, Honeywell, Colgate Palmolive, Royal Copenhagen, Hella.

Marine

Freedom of the Seas, Liberty of the Seas, Norwegian Star, Color Magic, Pride of Hawaii, Galaxy, AIDA Diva, Celebrity Solstice. MY Platinum (Dubai Ports Authority), M/S Caravelle (Jade Yachts), Safari (Blohm & Voss) Lady Haya (Pesaro), Pelorus (Lürssen Kröger Werft), Oceanco Kusch Yachts Agentur. 3 vehicle carriers and 10 container ships (MHI Japan), 6 container vessels (AP Møller), 35 commercial vessels (Mawai China), 24 container vessels (Dalian Shipyards China). Agbami Off Shore, Consafe-Aberdeen Oil Platform Bingo I & Bingo II Offshore Oil Rigs. Auxillary vessel (British Navy), 5 frigates (Norwegian Navy), 2 logistics vessels (Danish Navy), 2 survey vessels Dutch Navy.

The BLÜCHER® range comprises:

BLÜCHER® Drain Domestic



Shower drains for concrete/tiled and vinyl floors

- SQUARE, TRIO and CIRCLE
- Removable and easy-to-clean water trap
- Range of design gratings



WaterLine shower channels for concrete/tiled and vinyl floors

- For installation against wall(s) or away from walls
- Range of design gratings

BLÜCHER® Drain Industrial



Industrial drains for concrete/tiled, resin or vinyl floors

- SQUARE and CIRCLE
- Removable and easy-to-clean water trap
- Large range of gratings for all applications and load classes

BLÜCHER® EuroPipe



Push-fit drainage pipes and fittings, Ø40-Ø315 mm

- Low weight, high strength
- For vacuum and gravity systems
- RS82 renovation system (see separate catalogue)

BLÜCHER® Channel



Channels and kitchen channels for concrete/tiled, resin and vinyl floors

- Removable and easy-to-clean water trap
- Large range of gratings for all applications and load classes

BLÜCHER® HygienicPro



Point and linear drains for applications with strict requirements to hygiene and high capacity, e.g. production areas in the food and beverage industry

- Quickly leads away solid waste, even at small water volumes
- No corners and cavities inside thus preventing bacterial growth
- Less production stops for emptying and cleaning filter baskets

BLÜCHER® Drain Roof



Roof drainage system for single-ply membrane or bitumen in gravity and vacuum systems

- Roof drains and BLÜCHER® EuroPipe pipework system
- Easy installation
- Long product life expectancy

BLÜCHER® product catalogues can be ordered from our customer center or downloaded from www.blucher.com



BLÜCHER® CHANNEL

Presentation of channels and kitchen channels.	1
Channels for concrete, tiled and resin floors without membrane.	34
Channels for concrete, tiled and resin floors with liquid membrane.	40
Channels for vinyl floors.	43
Kitchen channels for concrete, tiled and resin floors without membrane.	45
Kitchen channels for concrete, tiled and resin floors with liquid membrane.	46
Kitchen channels for vinyl floors.	48
Lower parts for channels and kitchen channels - without membrane flange.	49
Lower parts for channels and kitchen channels - with liquid membrane flange.	51
Lower parts for channels and kitchen channels - with sheet membrane flange.	52
Accessories for channels and kitchen channels.	53
Type number definition, installation heights and load class overview.	74



Channels and kitchen channels for commercial and industrial applications



Standard or customised solutions
Hygienic design
Gratings for any purpose and load class

Applications

For concrete, tiled, vinyl and epoxy flooring in:

- Industrial areas
- Commercial kitchens

Details

- Standard lengths 1 - 6 m (slot channels up to 12 m)
- Longitudinal and cross fall
- Several standard widths
- 2 mm material thickness (vinyl channels 1,5 mm)
- 20 mm frame width
- Anchor tangs
- Gratings for weight loads from 250 to 12000 kg
- Combinable with BLÜCHER® Drain Industrial accessories
- Stainless steel AISI304/EN 1.4301

Variants

- Outlet placed in end or center
- With or without outlet box
- With or without membrane flange

Options

- Removable water trap or P-trap
- Filter basket and sand bucket

Extras

- Reinforced frames for heavy weight loads
- Stabiliser angle and adjustable legs
- Protective strip and grating lock device

Specialised in customised channels

Product database at www.blucher.com

Standard channel range or custom solutions

Standard channel range

The BLÜCHER® standard channel range comprises drainage channels for all common applications and for all common floor types, i.e. for concrete/tiled/resin floors or for vinyl floors.

Selecting a channel from the standard range is easy: Use the tables to identify type number for the channel to be selected. Then select grating, lower part and accessories, using the diagrams.

Most standard channels can be supplied from stock with short lead times.

Options and extras

Stabiliser angles, adjustable legs, edge infill, etc. are among the options available for the standard channel range.



Custom solutions

In addition to the BLÜCHER® standard channel range, BLÜCHER also offers purpose-made channels on request to ensure that all drainage requirements can be satisfied, for instance:

- Channels with corners
- Channels with T-pieces
- Channels in customized lengths
- Channels and gratings in customized widths
- Channels in customized designs
- Channels for other types of flooring
- Channels in acid-resistant stainless steel grade AISI 316L for demanding environments
- Other types of gratings

Our drainage know-how enables us to provide extensive engineering assistance.

For further information please contact our sales department.

Complete channels and kitchen channels

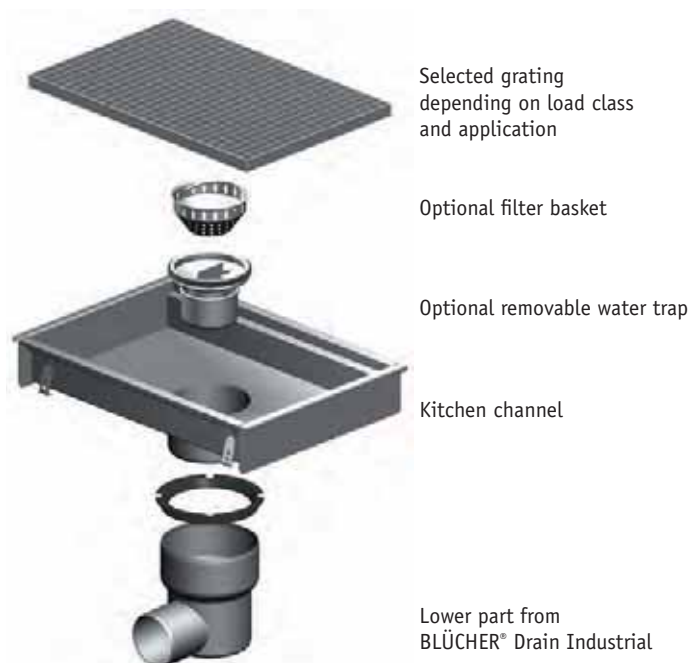
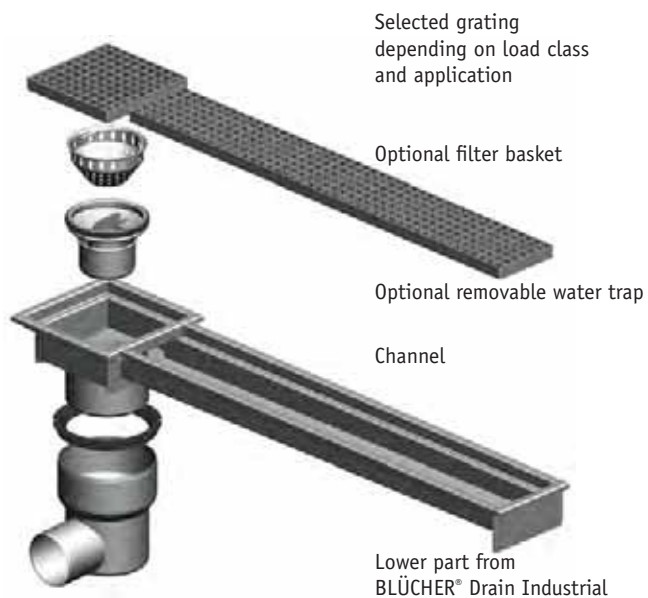

Complete channels and kitchen channels

Channels or kitchen channels

Channel or kitchen channel without grating

Gratings

Range of gratings for all load classes.

Accessories

Accessories such as filter basket, sand bucket and water trap are not included - to be ordered separately

Lower part

Lower part with outlet is not included - to be ordered separately.

HygienicPro®



Matching the strictest hygiene requirements

The HygienicPro® range:

- Point drains or linear drains with center or end outlet
- Channel lengths 1 - 10 metres
- Channel lengths connected to outlet box at different angles
- Outlet box and filter basket in three sizes
- Vertical or horizontal outlet

With a product range consisting of modular components with numerous possible combinations complemented by project-designed bespoke products, BLÜCHER provides customer specific and hygienic drainage solutions to match any drainage project.

A WATTS Brand



Type 674



Type 672



Type 673



Type 670



Type 677



Type 660



The right solution

Selecting a channel system

Take the issues below into account to make sure that you select the right channel system for your drainage requirement:

- **Floor covering**
Concrete/tiled/resin or vinyl floors
- **Membrane type**
Where required, liquid or sheet membrane application will determine the choice of lower part
- **Weight load**
Can influence the choice of channel width as well as determine the most appropriate grating for the application
- **Stainless steel grade**
AISI 304 (EN 1.4301) or alternatively AISI 316L (EN 1.4404) for applications where detergents are frequently used, but no large water volumes are available for flushing. See table of chemical resistance.
- **Water load**
 - continuous water flow
 - intermittent discharge
 - washdown

It is important to ensure that the lower part and water trap arrangement has adequate flow capacity for the application.
- **Waste products**
Where possible, the type of grating chosen should permit pieces of waste to pass through for collection in a filter basket.
- **Standard options**

Floor drainage methods

Channel or floor drain?

To choose between channel and floor drain it is necessary to consider the use and design of the room. For instance, the number and location of discharge points, frequency of discharge, the volume of water, the size of the room and the nature of the traffic in the room.

The following factors indicate that channels should be considered:

- **Many discharge points**
It is possible to install a channel network such that individual discharge points are picked up and water does not cover the entire floor and cause a safety hazard.
- **Large floor area**
Installing a channel in a large room allows the floor to be laid with less fall.
- **Large quantities of surface water**
The water content of a large channel acts as a buffer and reduces slip hazards.
- **Breakwater**
A channel in a door opening will isolate designated wet and dry areas.

Standard variants and options

For all channel types a range of variants and options as described below can be specified:

Variants



A: Stabilizer angle



B: Anchor tangs

Anchoring the channel firmly into the concrete is particularly important for channels that will be exposed to heavy weight loads and large temperature variations.

Stabilizer angle (variant A) is point welded to the channel, thus supporting the channel and creating a bond between channel and concrete in the entire length of the channel. Adjustable legs and anchor tangs can be fitted in the stabilizer angle. The stabilizer angle is recommended for all applications with heavy weight load.

Anchor tangs (variant B) are welded to the channel side at 500 mm distance. Before embedding the channel in concrete, the anchor tangs are bent out. Adjustable legs can be fitted into the holes of the anchor tangs. Anchor tangs are suitable for applications without high weight loads or thermal stress, for instance in shower rooms or light industrial applications.

Stabilizer angle and anchor tangs can be fitted with adjustable legs (type no. 670.000.001) to be able to adjust the position of the channel before embedding in concrete.

Options



B: Edge infill



C: Protective strip

Edge infill (option B) – For optimum channel strength it is important that the channel is properly embedded in concrete. This is particularly necessary with regards to the underside of the channel edge profile. Whilst this can be filled on site it is also possible to have the filling carried out under factory conditions as part of the production process.

In addition to providing greater rigidity to the channel, the edge infill also eliminates voids and any potential for bacterial growth.

Protective strip (option C) The edge profile can be supplied with a protective strip which adheres lightly and is easily removed. This is to protect the edge profile during installation leaving a perfect visible edge once the installation is complete.

Option A designates no edge infill or protective strip, and Option D designates edge infill and protective strip combined.

Channel type number explanation

6XX AA XXX-XX A A S

Example: 670CH010-00BA S (670 CH 010-00 B A S)

Material grade	
(blank)	Stainless steel AISI 304
S	Stainless steel AISI 316L
Option	
A	None
B	Edge infill
C	Protective strip on frame
D	Edge infill and protective strip on frame
Variant	
A	Stabiliser angle
B	Anchor tangs

Channel range overview

Type 670 Channel for concrete, tiled and resin floors

Width: 150, 200, 300 or 400 mm
 Length: 1 - 6 metres
 Typical application: Shower areas, kitchens, food and beverage production, chemical plants, abattoirs



Type 671 Channel with outlet box for concrete, tiled and resin floors

Width: 150 mm
 Length: 1 - 6 metres excl. outlet box
 Typical application: Kitchens, food and beverage production, chemical plants, abattoirs



Type 673 20 mm slot channel with outlet box for concrete, tiled and resin floors

Width: 20 mm aperture
 Length: 1 - 12 metres
 Grating: For outlet box only
 Typical application: Food and beverage production, chemical plants, breakwaters, abattoirs



Type 676 HygienicPro® channel for concrete, tiled and resin floors

Width: 150 mm
 Length: 1 - 10 metres
 Typical application: Hygienically demanding areas in food and beverage production



Type 674 Channel with 50 mm liquid membrane flange for concrete, tiled and resin floors

Width: 150, 200, 300 or 400 mm
 Length: 0,9 - 6 metres
 Typical application: Shower areas, kitchens, food and beverage production, chemical plants, abattoirs, dairies



Channel range overview

Type 677 **8 mm slot channel with 50 mm liquid membrane flange for concrete, tiled and resin floors**

Width: 8 mm aperture
Length: 1 - 3 metres
Typical application: Shower areas, swimming pools, breakwaters



Type 678 **Channel with 84 mm liquid membrane flange for concrete, tiled and resin floors**

Width: 150 mm
Length: 0,9 - 1,4 metres
Typical application: Shower areas, kitchens, food and beverage production, chemical plants, abattoirs, dairies



Type 672 **Channel for vinyl floors**

Width: 150, 200, 300 or 400 mm
Length: 0,9 - 6 metres
Typical application: Shower areas, kitchens



TYPE 670

Channel for concrete, tiled or resin floors

Width (grate location):	150, 200, 300 or 400 mm
Length (grate location):	1 - 6 metres
Outlet:	OD110 and OD160 mm
Outlet position:	End or center

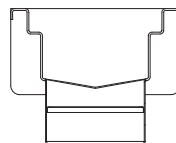

Installation examples

Linear drainage in commercial kitchen, typically fitted with mesh gratings in 0,5 m lengths

With linear drainage it is easy to create the correct fall in the floor, and a large area can be drained in one location.

Mesh gratings are the ideal choice for kitchen areas as they are light-weight and non-skid. In lengths of 0,5 m they fit into an industrial dishwasher for cleaning.

Channels with grate location width 150 mm have OD110 mm outlet and channels with larger grate location widths have outlet OD110 or OD160 mm. The outlet can be connected to a "P" water trap or a removable water trap and a filter basket.

Linear drainage in food industry, typically fitted with HygienicPro gratings

With linear drainage it is easy to create the correct fall in the floor, and a large area can be drained in one location.

HygienicPro cast stainless steel gratings are the ideal choice for the food industry as they have a good weight/strength ratio and are very easy to clean, thereby contributing to excellent hygiene.

Channels with grate location width 150 mm have OD110 mm outlet and channels with larger grate location widths have outlet OD110 or OD160 mm. The outlet can be connected to a "P" water trap or a removable water trap and a filter basket.

See grating specifications for non-skid levels and load classes.

Customized channels

BLÜCHER offers custom-made channels for all applications. Our team of technical engineers holds over 40 years of know-how and experience in designing channels with customer-specific angles, shapes, widths, depths and outlet dimensions.

For customized channels we also design customized gratings to fit the exact dimensions of the customized channel.

For more information please contact our technical sales department.

Accessories

Accessories and outlet configurations available for channel type 670:

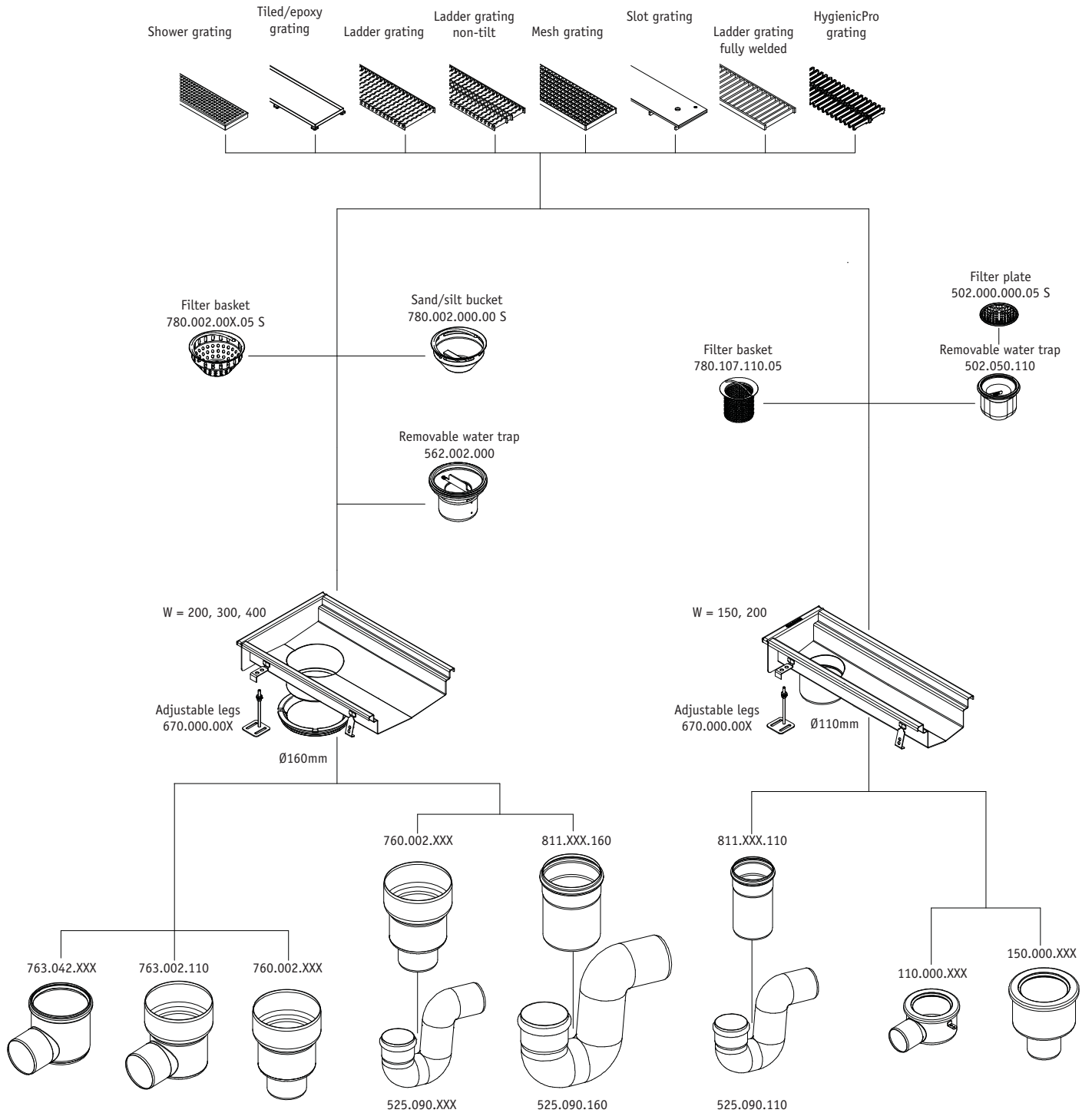

TYPE 671

Channel with outlet box for concrete, tiled or resin floors

Width (grate location):	150 mm
Length (grate location):	1 - 6 metres
Outlet:	OD160 mm
Outlet position:	End or center

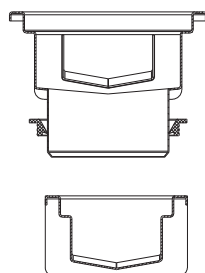

Installation examples

Linear drainage in industrial facilities, typically fitted with ladder gratings

With linear drainage it is easy to create the correct fall in the floor, and a large area can be drained in one location.

Ladder gratings are the ideal choice for industrial facilities as they are in a relatively high load class and have a high non-skid value.

The channels have 150 mm grate location width and OD160 mm outlet that can be connected to a "P" water trap or a removable water trap and a filter basket.

The ladder grating is available in sizes fitting the channel and the outlet box.

Linear drainage in food industry/industrial facilities, typically fitted with slot gratings

With linear drainage it is easy to create the correct fall in the floor, and a large area can be drained in one location.

Slot gratings are the ideal choice for the food industry where strength (high load class) and hygiene are essential.

The channels have 150 mm grate location width and OD160 mm outlet that can be connected to a "P" water trap or a removable water trap and a filter basket.

The slot grating is available in sizes fitting the channel and the outlet box.

See grating specifications for non-skid levels and load classes.

Customized channels

BLÜCHER offers custom-made channels for all applications. Our team of technical engineers holds over 40 years of know-how and experience in designing channels with customer-specific angles, shapes, widths, depths and outlet dimensions.

For customized channels we also design customized gratings to fit the exact dimensions of the customized channel.

For more information please contact our technical sales department.

Accessories

Accessories and outlet configurations available for channel type 671:

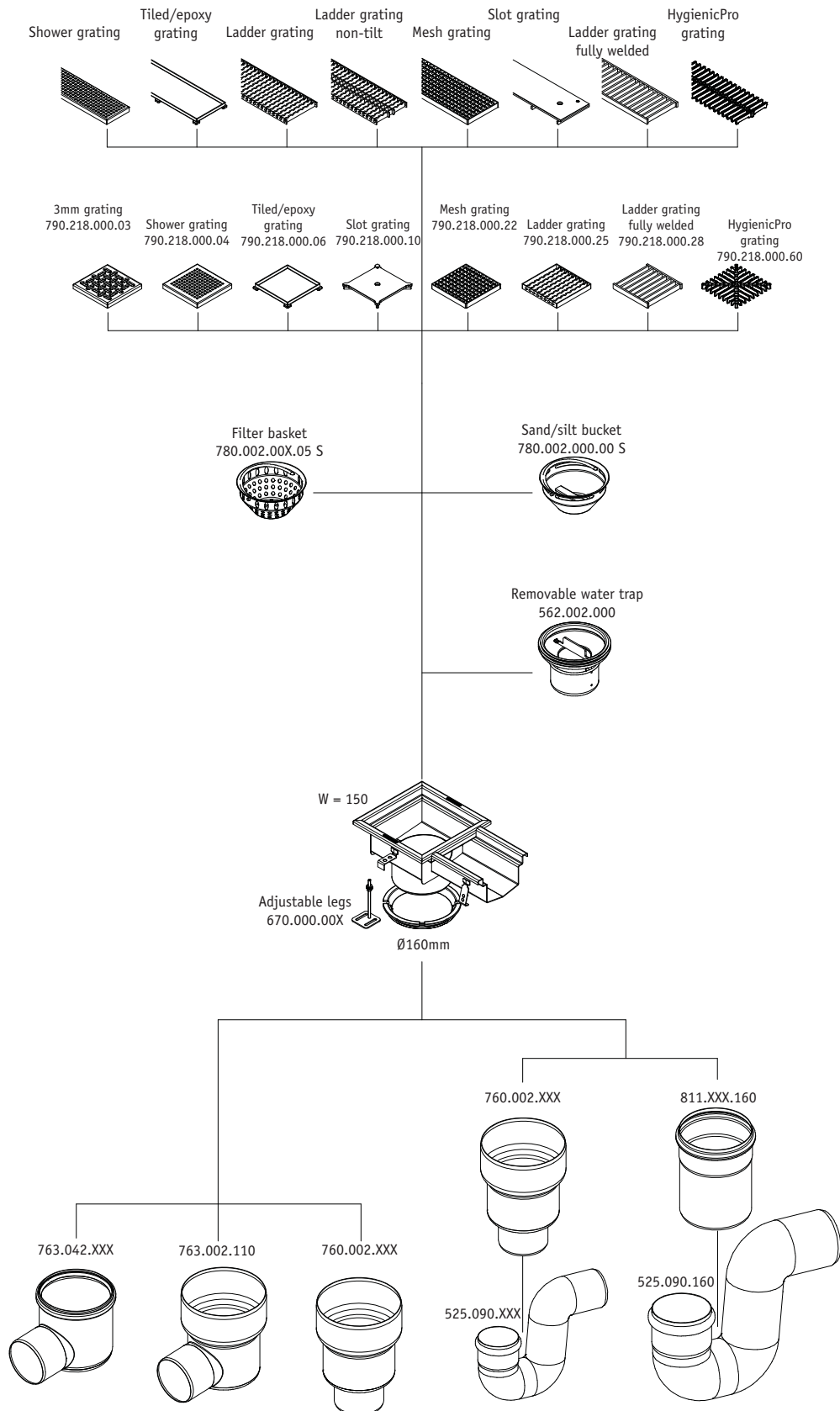

TYPE 673

20 mm slot channel with outlet box for concrete, tiled or resin floors

Aperture:	20 mm
Length (grate location):	1 - 12 metres
Outlet:	OD160 mm
Outlet position:	End or center



Installation examples

Linear drainage in commercial kitchens, typically fitted with non-skid mesh gratings in the outlet box

With linear drainage it is easy to create the correct fall in the floor, and a large area can be drained in one location.

Particularly suitable as breakwater in floors with considerable water discharge to separate wet and dry zones.

The total visible width of the channels is 60 mm, and they have OD160 mm outlet that can be connected to a "P" water trap or a removable water trap and a filter basket.

Linear drainage in industrial facilities, typically fitted with ladder gratings in the outlet box

With linear drainage it is easy to create the correct fall in the floor, and a large area can be drained in one location.

Particularly suitable as breakwater in floors with considerable water discharge to separate wet and dry zones, with ladder grating for high weight load

The total visible width of the channels is 60 mm, and they have OD160 mm outlet that can be connected to a "P" water trap or a removable water trap and a filter basket.

See grating specifications for non-skid levels and load classes.

Customized channels

BLÜCHER offers custom-made channels for all applications. Our team of technical engineers holds over 40 years of know-how and experience in designing channels with customer-specific angles, shapes, widths, depths and outlet dimensions. For customized channels we also design customized gratings to fit the exact dimensions of the customized channel. For more information please contact our technical sales department.

Accessories

Accessories and outlet configurations available for channel type 673:

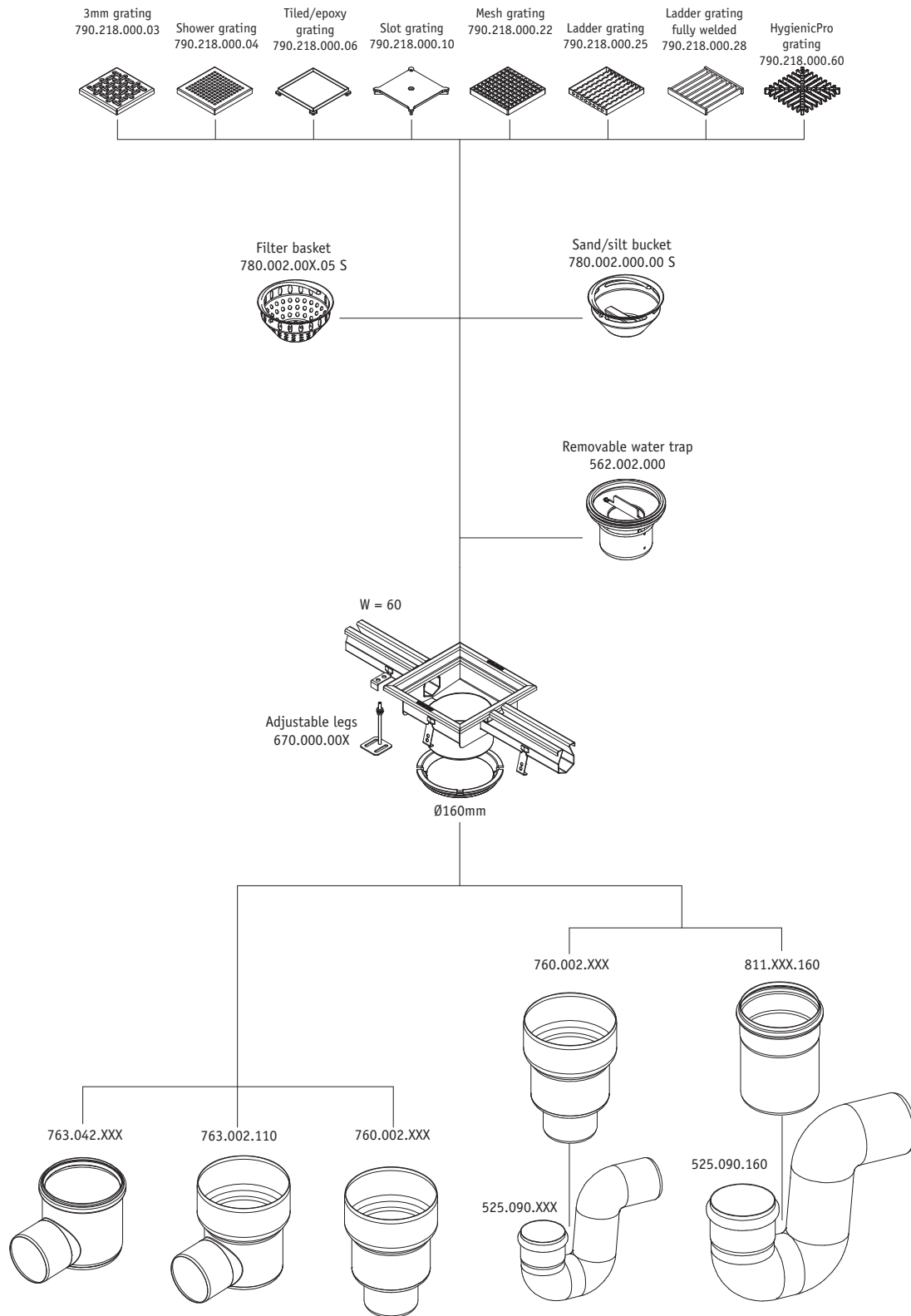

TYPE 676

HygienicPro® Channel for concrete, tiled or resin floors

Width (grate location): 150 mm
 Length (grate location): 1 - 10 metres
 Outlet: OD110 mm
 Outlet position: End or center

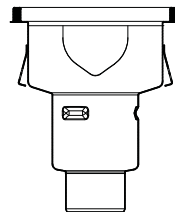

Installation examples

Linear drainage in hygienically demanding areas in the food and beverage industry, typically fitted with HygienicPro® grating

HygienicPro® are high-capacity channels that provide efficient flow and a high level of self-cleaning. They are easy to clean and prevent bacterial growth while limiting also the water volumes and the production time necessary for operating and cleaning the drainage system.

The outlet can be connected to a "P" water trap or a removable water trap and a filter basket.



Production downtime reduced
thanks to high-capacity filter basket



Efficient flow towards outlet
New channel geometry keeps channels empty and clean during minimal water flow periods



Hygienic floor concept
due to rounded corners providing durable floor joints



Easy and efficient floor cleaning
Grating with open sides, rounded corners and no cavities prevents waste and residues from depositing on the grating surface

High-flow water trap

Increases flow rate and improves hygiene by emptying the channel/drain faster. Separable for easy cleaning



Heavy-duty frame for secure bonding to floor

Improving hygiene and durability with frame edge infill and special anchor tangs, minimizing risk of deformation and flooring cracks



Neat and hygienic bonding

between floor and drain owing to heavy-duty frame































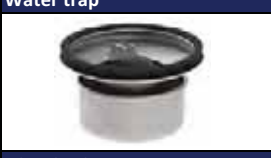

See grating specifications for non-skid levels and load classes.

Customized channels

BLÜCHER offers custom-made channels for all applications. Our team of technical engineers holds over 40 years of know-how and experience in designing channels with customer-specific angles, shapes, widths, depths and outlet dimensions. For customized channels we also design customized gratings to fit the exact dimensions of the customized channel. For more information please contact our technical sales department.

Accessories

Accessories and outlet configurations available for channel type 676 HygienicPro®:

Configure your individual HygienicPro® channel					
Profile	A	B	C	D	
					
Length	LA	LB	LC	LD	
	0,5m	0,5m	0,5m	0,5m	
	1m	1m	1m	1m	
	1,5m	1,5m	1,5m	1,5m	
	2m	2m	2m	2m	
	2,5m	2,5m	2,5m	2,5m	
	3m	3m	3m	3m	
	3,5m	3,5m	3,5m	3,5m	
	4m	4m	4m	4m	
	4,5m	4,5m	4,5m	4,5m	
	5m	5m	5m	5m	
Outlet	Vertical	Horizontal			
					
Horizontal outlet angle	0°	90°	180°	270°	Other
	Below channel 				
Grating	Drain	Channel	Channel		
	790.273.000.60 	697.250.150.57 	697.250.150.50 		
Water trap	Water trap				
	562.102.000 				
Filter basket	Low	Medium	High		
	780.004.010.05 	780.004.020.05 	780.004.030.05 		
Accessories	Filter 500mm	Tile adapters	Funnel	Filter spacer	
	780.005.150.05 	670.000.020 Tile adaptor end  670.000.021 Tile adaptor center 	670.005.000 	670.000.010 	

TYPE 674

Channel with 50 mm liquid membrane flange for concrete, tiled or resin floors

Width (grate location): 150, 200, 300 or 400 mm
 Length (grate location): 0,9 - 6 metres
 Outlet: OD110 and OD160 mm
 Outlet position: End or center

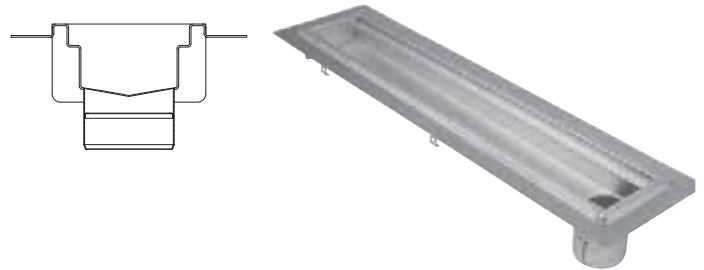

Installation examples

Linear drainage in commercial shower room, typically fitted with shower grating

With linear drainage it is easy to create the correct fall in the floor, and a large area can be drained in one location.

The shower grating is approved for barefoot areas and consequently particularly suitable for shower rooms. In addition, the large open area ensures high flow through the grating.

Channels with grate location width 150 mm have OD110 mm outlet and channels with larger grate location widths have outlet OD110 or OD160 mm. The outlet can be connected to a "P" water trap or a removable water trap and a filter basket.

Linear drainage in commercial shower room with focus on design, typically fitted with tiled/epoxy grating

With linear drainage it is easy to create the correct fall in the floor, and a large area can be drained in one location.

The tiled/epoxy grating is approved for barefoot areas and consequently particularly suitable for shower rooms. In addition, the 8 mm aperture between grating and frame ensures high flow through the grating.

Channels with grate location width 150 mm have OD110 mm outlet and channels with larger grate location widths have outlet OD110 or OD160 mm. The outlet can be connected to a "P" water trap or a removable water trap and a filter basket.

See grating specifications for non-skid levels and load classes.

Customized channels

BLÜCHER offers custom-made channels for all applications. Our team of technical engineers holds over 40 years of know-how and experience in designing channels with customer-specific angles, shapes, widths, depths and outlet dimensions. For customized channels we also design customized gratings to fit the exact dimensions of the customized channel. For more information please contact our technical sales department.

Accessories

Accessories and outlet configurations available for channel type 674:

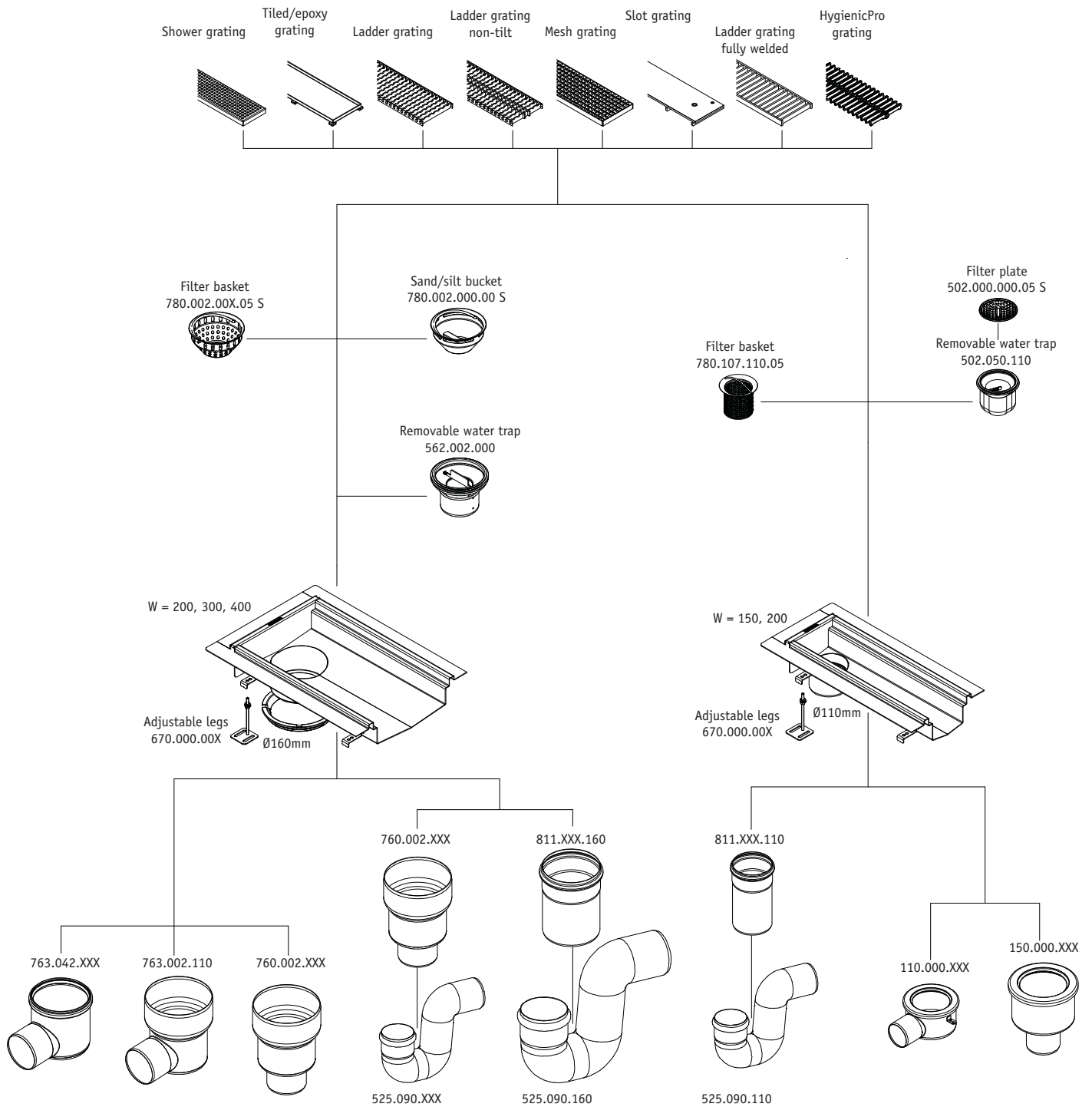

TYPE 677

8 mm slot channel with 50 mm liquid membrane flange for concrete, tiled or resin floors

Aperture:	8 mm
Length (grate location):	1 - 3 metres
Outlet:	OD50 mm
Outlet position:	End, horizontal



Installation example

Linear drainage in commercial shower areas/wet rooms

With linear drainage it is easy to create the correct fall in the floor, and a large area can be drained in one location.

Particularly suitable as breakwater in floors with considerable water discharge to separate wet and dry zones. 8 mm aperture.

The total visible width of the channels is 48 mm, and they have OD50 mm outlet at the channel end that can be connected to either a "P" water trap.

Comes with 50 mm liquid membrane flange.

Customized channels

BLÜCHER offers custom-made channels for all applications. Our team of technical engineers holds over 40 years of know-how and experience in designing channels with customer-specific angles, shapes, widths, depths and outlet dimensions.

For customized channels we also design customized gratings to fit the exact dimensions of the customized channel.

For more information please contact our technical sales department.

Accessories

Accessories and outlet configurations available for channel type 677:

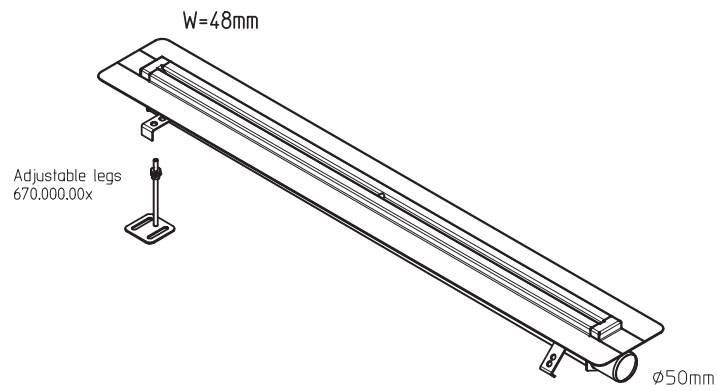

TYPE 678

Channel with 84 mm liquid membrane flange for concrete, tiled or resin floors

Width (grate location):	150 mm
Length (grate location):	0,9 - 1,4 metres
Outlet:	OD110 mm
Outlet position:	End

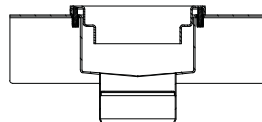

Installation examples

Linear drainage in commercial shower room, typically fitted with shower grating

With linear drainage it is easy to create the correct fall in the floor, and a large area can be drained in one location.

The shower grating is approved for barefoot areas and consequently particularly suitable for shower rooms. In addition, the large open area ensures high flow through the grating.

The outlet can be connected to a "P" water trap or a removable water trap and a filter basket.

Linear drainage in commercial shower room with focus on design, typically fitted with tiled/epoxy grating

With linear drainage it is easy to create the correct fall in the floor, and a large area can be drained in one location.

The tiled/epoxy grating is approved for barefoot areas and consequently particularly suitable for shower rooms. In addition, the 8 mm aperture between grating and frame ensures high flow through the grating.

The outlet can be connected to a "P" water trap or a removable water trap and a filter basket.

See grating specifications for non-skid levels and load classes.

Customized channels

BLÜCHER offers custom-made channels for all applications. Our team of technical engineers holds over 40 years of know-how and experience in designing channels with customer-specific angles, shapes, widths, depths and outlet dimensions. For customized channels we also design customized gratings to fit the exact dimensions of the customized channel. For more information please contact our technical sales department.

Accessories

Accessories and outlet configurations available for channel type 678:

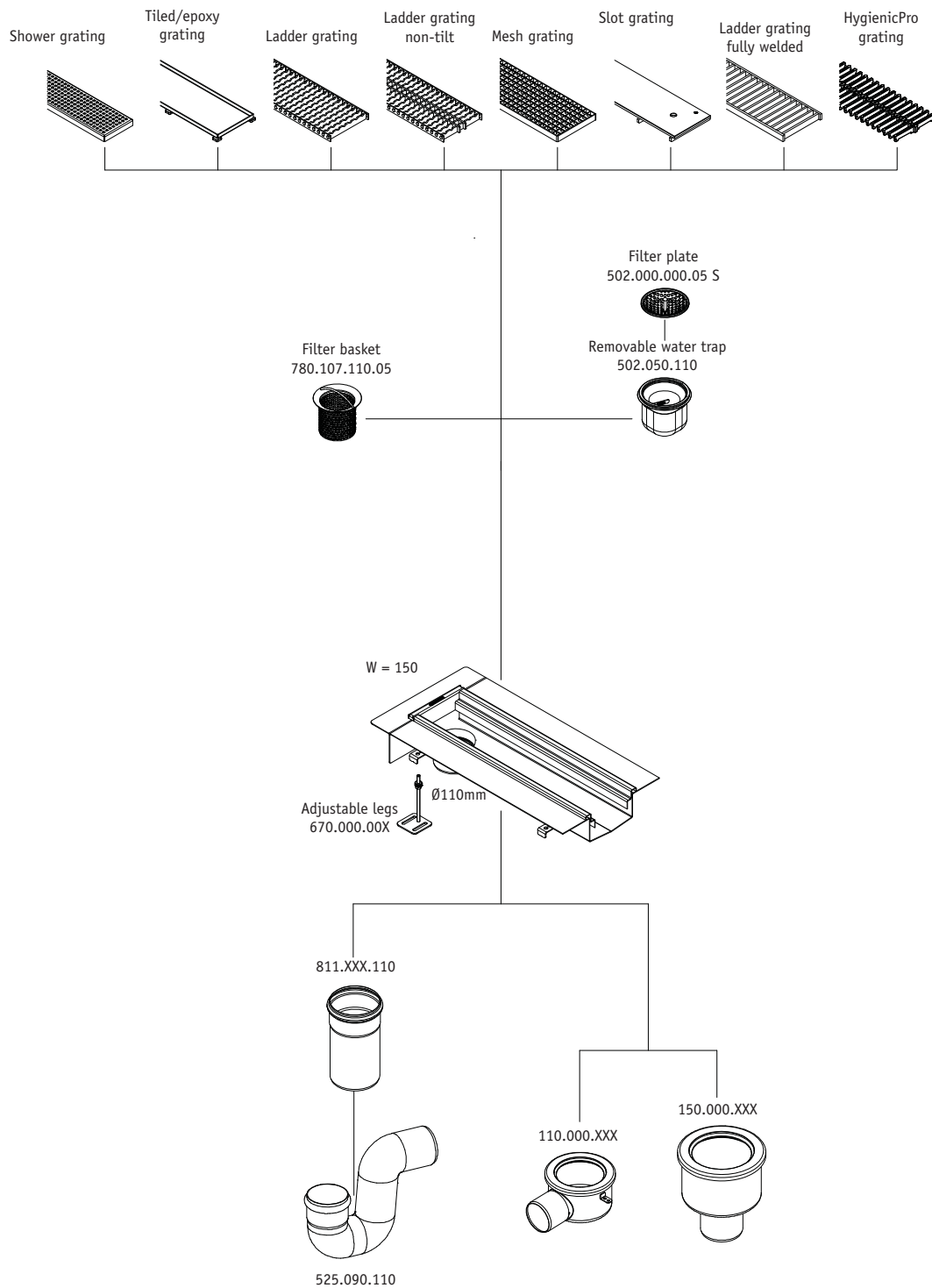

TYPE 672

Channel for vinyl floors

Width (grate location):	150, 200, 300 or 400 mm
Length (grate location):	0,9 - 6 metres
Outlet:	OD110 and OD160 mm
Outlet position:	End or center

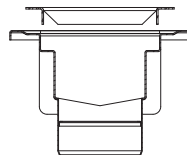

Installation examples

Linear drainage in commercial shower room with vinyl floor, typically fitted with tiled/epoxy grating where design is a parameter

With linear drainage it is easy to create the correct fall in the floor, and a large area can be drained in one location.

The tiled/epoxy grating is approved for barefoot areas and consequently particularly suitable for shower rooms. In addition, the 8 mm aperture between grating and frame ensures high flow through the grating. Channels with grate location width 150 mm have OD110 mm outlet and channels with larger grate location widths have outlet OD110 or OD160 mm. The outlet can be connected to a "P" water trap or a removable water trap and a filter basket.

Linear drainage in commercial shower room with vinyl floor, typically fitted with shower grating

With linear drainage it is easy to create the correct fall in the floor, and a large area can be drained in one location.

The shower grating is approved for barefoot areas and consequently particularly suitable for shower rooms. In addition, the large open area ensures high flow through the grating.

Channels with grate location width 150 mm have OD110 mm outlet and channels with larger grate location widths have outlet OD110 or OD160 mm. The outlet can be connected to a "P" water trap or a removable water trap and a filter basket.

See grating specifications for non-skid levels and load classes.

Customized channels

BLÜCHER offers custom-made channels for all applications. Our team of technical engineers holds over 40 years of know-how and experience in designing channels with customer-specific angles, shapes, widths, depths and outlet dimensions.

For customized channels we also design customized gratings to fit the exact dimensions of the customized channel.

For more information please contact our technical sales department.

Accessories

Accessories and outlet configurations available for channel type 672:

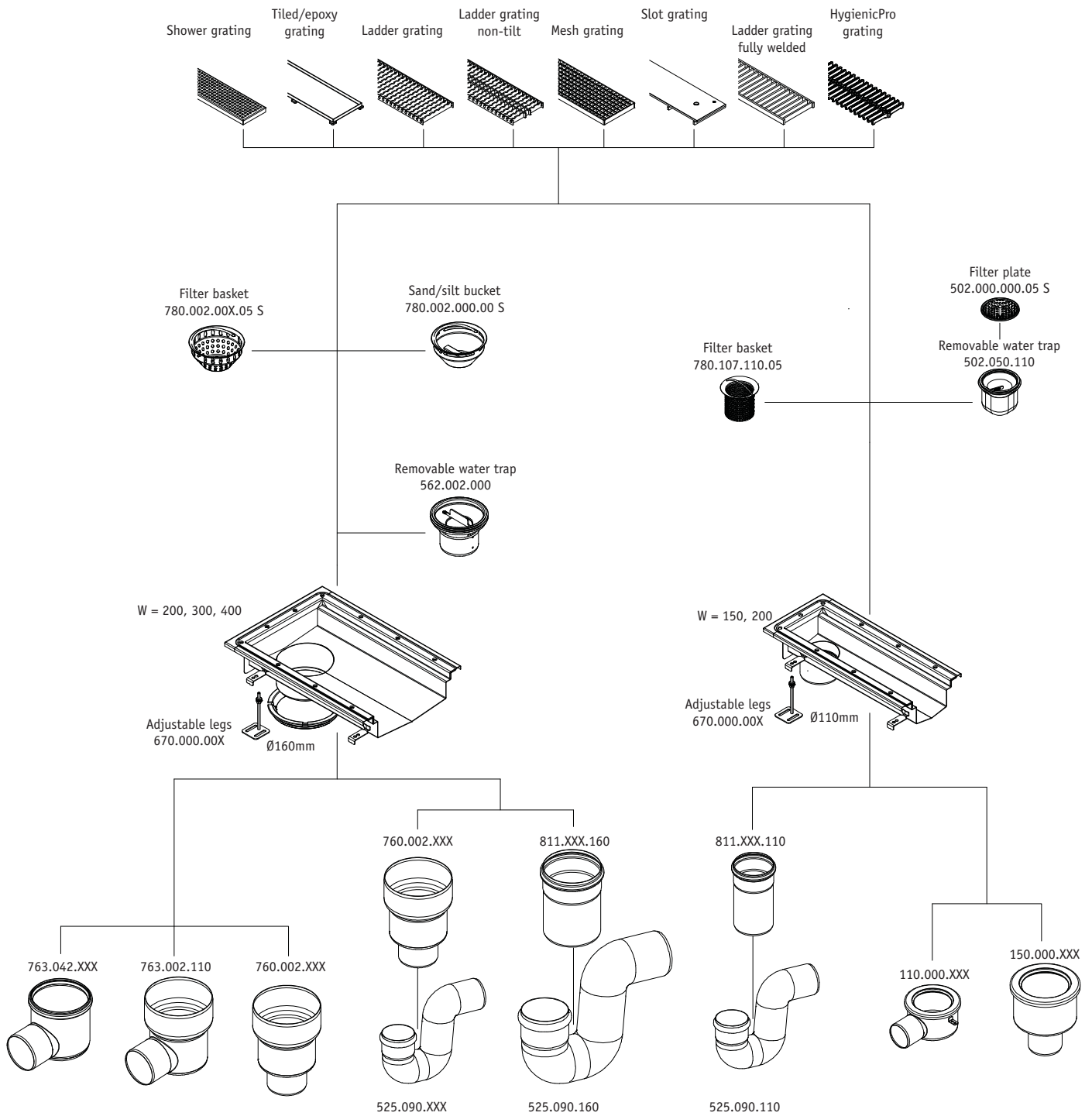

Kitchen Channel Range Overview

Type 660

Width (grate location):
Length (grate location):
Typical applications:

Kitchen channel for concrete, tiled and resin floors

300, 400, 500 or 600 mm
400, 500, 800, 900 or 1000 mm
Kitchens, food and beverage production, chemical plants, abattoirs



Type 664

Width (grate location):
Length (grate location):
Typical applications:

Kitchen channel with 50 mm liquid membrane flange for concrete, tiled and resin floors

300, 400, 500 or 600 mm
400, 500, 800, 900 or 1000 mm
Kitchens, food and beverage production, chemical plants, abattoirs, dairies



Type 668

Width (grate location):
Length (grate location):
Typical applications:

Kitchen channel with 100 mm liquid membrane flange for concrete, tiled and resin floors

200, 300, 400, 500 or 600 mm
200, 300, 400, 500, 600, 800, 900 or 1000 mm
Kitchens, food and beverage production, chemical plants, abattoirs, dairies



Type 662

Width (grate location):
Length (grate location):
Typical applications:

Kitchen channel for vinyl floors

300, 400, 500 or 600 mm
400, 500, 800, 900 or 1000 mm
Kitchens



TYPE 660

Kitchen channel for concrete, tiled and resin floors

Width (grate location): 300, 400, 500 or 600 mm

Length (grate location): 400, 500, 800, 900
or 1000 mm

Outlet: OD110 and OD160 mm

Outlet position: Kitchen channel center

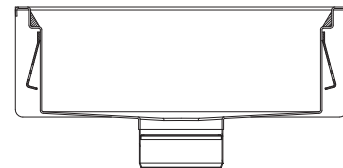

Installation example

Drainage in commercial kitchen, typically fitted with mesh grating

With a kitchen channel it is easy to create the correct fall in the floor, and a large area can be drained in one location and directly into the kitchen channel.

Mesh gratings are the ideal choice for kitchen areas as they are light-weight and non-skid. In addition, they fit into an industrial dishwasher for cleaning.

Kitchen channels have OD110 or OD160 mm outlet.

The outlet can be connected to a "P" water trap or a removable water trap and a filter basket.

Customized kitchen channels

BLÜCHER offers custom-made channels for all applications. Our team of technical engineers holds over 40 years of know-how and experience in designing kitchen channels with customer-specific angles, shapes, widths, depths and outlet dimensions. For customized kitchen channels we also design customized gratings to fit the exact dimensions of the kitchen channel. For more information please contact our technical sales department.

TYPE 664

Kitchen channel with 50 mm liquid membrane flange, for concrete, tiled and resin floors

Width (grate location): 300, 400, 500 or 600 mm

Length (grate location): 400, 500, 800, 900
or 1000 mm

Outlet: OD110 and OD160 mm

Outlet position: Kitchen channel center

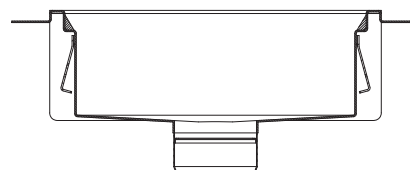

Installation example

Drainage in commercial kitchen/wet zones, typically fitted with mesh grating

With a kitchen channel it is easy to create the correct fall in a floor with liquid membrane, and a large area can be drained in one location and directly into the kitchen channel.

Mesh gratings are the ideal choice for kitchen areas as they are light-weight and non-skid. In addition, they fit into an industrial dishwasher for cleaning.

Kitchen channels have OD110 or OD160 mm outlet

The outlet can be connected to a "P" water trap or a removable water trap and a filter basket.

Customized kitchen channels

BLÜCHER offers custom-made channels for all applications. Our team of technical engineers holds over 40 years of know-how and experience in designing kitchen channels with customer-specific angles, shapes, widths, depths and outlet dimensions. For customized kitchen channels we also design customized gratings to fit the exact dimensions of the kitchen channel. For more information please contact our technical sales department.

TYPE 668

Kitchen channel with 100 mm liquid membrane flange, for concrete, tiled and resin floors

Width (grate location): 200, 300, 400, 500 or 600 mm
 Length (grate location): 200, 300, 400, 500, 600, 800, 900 or 1000 mm
 Outlet: OD160 mm
 Outlet position: Kitchen channel center



Installation example

Drainage in commercial kitchen/wet zones, typically fitted with mesh grating

With a kitchen channel it is easy to create the correct fall in a floor with liquid membrane, and a large area can be drained in one location and directly into the kitchen channel.

Mesh gratings are the ideal choice for kitchen areas as they are light-weight and non-skid. In addition, they fit into an industrial dishwasher for cleaning.

Kitchen channels have OD110 or OD160 mm outlet
 The outlet can be connected to a "P" water trap or a removable water trap and a filter basket.

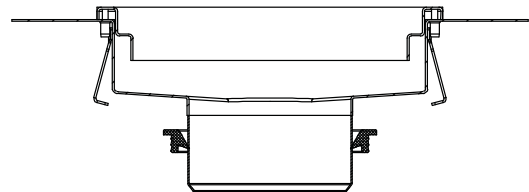

Customized kitchen channels

BLÜCHER offers custom-made channels for all applications. Our team of technical engineers holds over 40 years of know-how and experience in designing kitchen channels with customer-specific angles, shapes, widths, depths and outlet dimensions. For customized kitchen channels we also design customized gratings to fit the exact dimensions of the kitchen channel. For more information please contact our technical sales department.

TYPE 662

Kitchen channel for vinyl floors

Width (grate location):	300, 400, 500 or 600 mm
Length (grate location):	400, 500, 800, 900 or 1000 mm
Outlet:	OD110 and OD160 mm
Outlet position:	Kitchen channel center

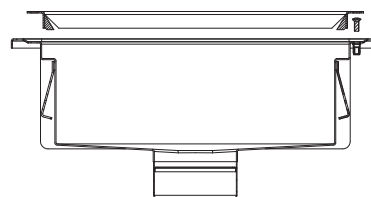

Installation example

Drainage in commercial kitchen/wet zones, typically fitted with mesh grating

With a kitchen channel it is easy to create the correct fall in a floor with sheet vinyl floor covering, and a large area can be drained in one location and directly into the kitchen channel.

Mesh gratings are the ideal choice for kitchen areas as they are light-weight and non-skid. In addition, they fit into an industrial dishwasher for cleaning.

Kitchen channels have OD110 or OD160 mm outlet. The outlet can be connected to a "P" water trap or a removable water trap and a filter basket.

Customized kitchen channels

BLÜCHER offers custom-made channels for all applications. Our team of technical engineers holds over 40 years of know-how and experience in designing kitchen channels with customer-specific angles, shapes, widths, depths and outlet dimensions. For customized kitchen channels we also design customized gratings to fit the exact dimensions of the kitchen channel. For more information please contact our technical sales department.

Accessories

Accessories and outlet configurations available for kitchen channels:

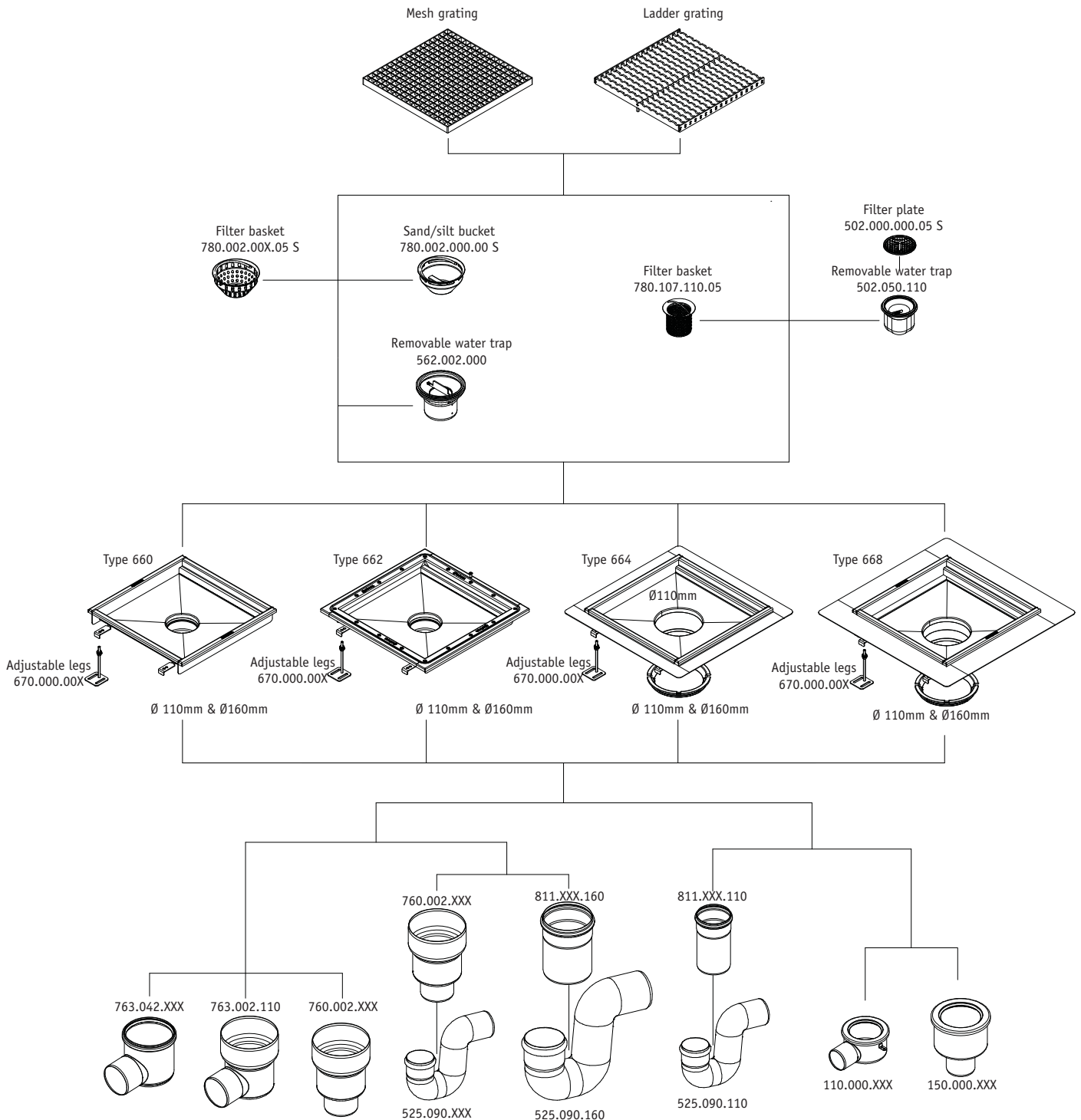

Channel standard gratings overview

HygienicPro grating

697.250.XXX.XX

Suitable where high load class, hygiene and design are parameters. Fully welded grating without crevices collecting dirt. Large aperture for quick discharge of fluid through the grating.

Available with rounded end for use in Type 676 HygienicPro® channels

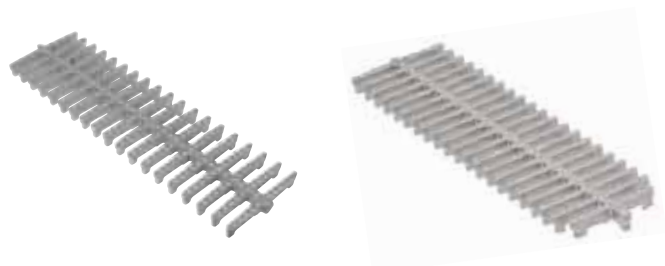

Ladder grating, 8 mm material, fully welded

697.225.XXX.XX

Suitable for industrial applications requiring safe non-skid surface and hygiene. Fully welded in 8 mm steel bars ensuring a high load class and no crevices collecting dirt and particles in the grating.



Slot grating

697.200.XXX.XX

Suitable where design and high flow capacity are parameters. 10 mm steel sheet with support bars and an aperture along the sides and ends of the grating for discharge of fluids.



Mesh grating

696.223.XXX.XX

Suitable for commercial kitchen where gratings with large aperture are necessary to ensure quick discharge of fluids through the grating.

Non-skid. Light-weight. Can be cleaned in industrial dishwasher.



Ladder grating, 25 mm height

697.125.XXX.XX

Suitable for industrial applications requiring safe non-skid surface and high load class. Grating can be turned upside down if non-skid surface is not requested. High load class and large aperture for quick discharge of fluid through the grating.



Ladder grating, non-tilt

697.127.XXX.XX

Similar to ladder grating 697.125.XXX.XX, but fitted with extra lengthwise support bars to enable the grating to withstand vehicles starting/braking lengthwise on the grating. Particularly suitable in areas with frequent heavy-loaded trucks lengthwise on the grating.



Channel standard gratings overview

Tiled/epoxy grating

697.020.XXX.XX

Suitable for shower rooms in commercial applications where design is a parameter. Approved for barefoot areas.

The grating is designed for fitting with tiles, concrete, epoxy or similar.

Load class depending on type of material fitted into the grating.



Shower grating

697.015.XXX.XX

Suitable for shower rooms and other barefoot areas as the holes in the gratings do not exceed 8 mm.

Not suitable for heavy weight loads (+250 kg). If a higher load class is requested in a barefoot area, we recommend the tiled/epoxy grating.

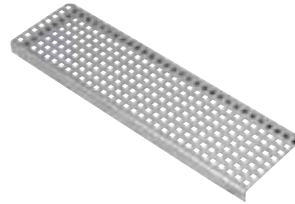

without membrane

CHANNEL TYPE 670

END OUTLET

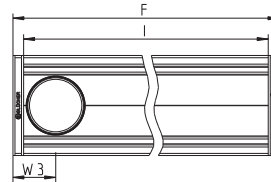
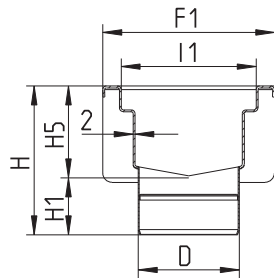

Type no.	EAN no.	Name	D	F	F1	H	H1	H5	I	I1	W3
670CH010-00BA	5705499125726	150x1000	110	1040	187	152	62	90	1000	147	80
670CH012-00BA	5705499135039	150x1200	110	1240	187	152	62	90	1200	147	80
670CH015-00BA	5705499125733	150x1500	110	1540	187	152	62	90	1500	147	80
670CH020-00BA	5705499125740	150x2000	110	2040	187	152	62	90	2000	147	80
670CH030-00BA	5705499125757	150x3000	110	3056	187	152	62	90	3016	147	80
670CH040-00BA	5705499129465	150x4000	110	4072	187	182	62	120	4032	147	80
670CH050-00BA	5705499129489	150x5000	110	5072	187	182	62	120	5032	147	80
670CH060-00BA	5705499129502	150x6000	110	6088	187	182	62	120	6048	147	80
670DH010-00BA	5705499129526	200x1000	110	1040	237	152	62	90	1000	197	80
670DH015-00BA	5705499129540	200x1500	110	1540	237	152	62	90	1500	197	80
670DH020-00BA	5705499129564	200x2000	110	2040	237	152	62	90	2000	197	80
670DH030-00BA	5705499129588	200x3000	110	3056	237	152	62	90	3016	197	80
670DH040-00BA	5705499129601	200x4000	110	4072	237	182	62	120	4032	197	80
670DH050-00BA	5705499129625	200x5000	110	5072	237	182	62	120	5032	197	80
670DH060-00BA	5705499129649	200x6000	110	6088	237	182	62	120	6048	197	80
670DK010-00BA	5705499125771	200x1000	160	1040	237	170	80	90	1000	197	105
670DK015-00BA	5705499125788	200x1500	160	1540	237	170	80	90	1500	197	105
670DK020-00BA	5705499125795	200x2000	160	2040	237	170	80	90	2000	197	105
670DK030-00BA	5705499125801	200x3000	160	3056	237	170	80	90	3016	197	105
670DK040-00BA	5705499129700	200x4000	160	4072	237	200	80	120	4032	197	105
670DK050-00BA	5705499129724	200x5000	160	5072	237	200	80	120	5032	197	105
670DK060-00BA	5705499129748	200x6000	160	6088	237	200	80	120	6048	197	105
670EK010-00BA	5705499129762	300x1000	160	1040	337	170	80	90	1000	297	105
670EK015-00BA	5705499129809	300x1500	160	1540	337	170	80	90	1500	297	105
670EK020-00BA	5705499129823	300x2000	160	2040	337	170	80	90	2000	297	105
670EK030-00BA	5705499129847	300x3000	160	3056	337	170	80	90	3016	297	105
670EK040-00BA	5705499129861	300x4000	160	4072	337	200	80	120	4032	297	105
670EK050-00BA	5705499129885	300x5000	160	5072	337	200	80	120	5032	297	105
670EK060-00BA	5705499129908	300x6000	160	6088	337	200	80	120	6048	297	105
670FK010-00BA	5705499129922	400x1000	160	1040	437	170	80	90	1000	397	105
670FK015-00BA	5705499129946	400x1500	160	1540	437	170	80	90	1500	397	105
670FK020-00BA	5705499129960	400x2000	160	2040	437	170	80	90	2000	397	105
670FK030-00BA	5705499129984	400x3000	160	3056	437	170	80	90	3016	397	105
670FK040-00BA	5705499130003	400x4000	160	4072	437	200	80	120	4032	397	105
670FK050-00BA	5705499130027	400x5000	160	5072	437	200	80	120	5032	397	105
670FK060-00BA	5705499130041	400x6000	160	6088	437	200	80	120	6048	397	105

without membrane

CHANNEL TYPE 670

CENTER OUTLET

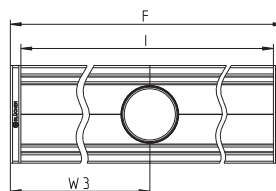
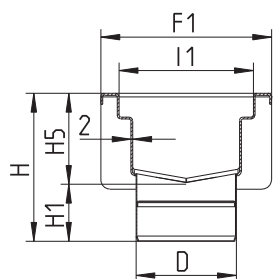

Type no.	EAN no.	Name	D	F	F1	H	H1	H5	I	I1	W3
670CH010-05BA	5705499129427	150x1000	110	1040	187	152	62	90	1000	147	520
670CH015-08BA	5705499129434	150x1500	110	1540	187	152	62	90	1500	147	770
670CH020-10BA	5705499129441	150x2000	110	2040	187	152	62	90	2000	147	1020
670CH030-15BA	5705499129458	150x3000	110	3056	187	152	62	90	3016	147	1528
670CH040-20BA	5705499129472	150x4000	110	4072	187	152	62	90	4032	147	2036
670CH050-25BA	5705499129496	150x5000	110	5072	187	152	62	90	5032	147	2536
670CH060-30BA	5705499129519	150x6000	110	6088	187	152	62	90	6048	147	3044

670DH010-05BA	5705499129533	200x1000	110	1040	237	152	62	90	1000	197	520
670DH015-08BA	5705499129557	200x1500	110	1540	237	152	62	90	1500	197	770
670DH020-10BA	5705499129571	200x2000	110	2040	237	152	62	90	2000	197	1020
670DH030-15BA	5705499129595	200x3000	110	3056	237	152	62	90	3016	197	1528
670DH040-20BA	5705499129618	200x4000	110	4072	237	152	62	90	4032	197	2036
670DH050-25BA	5705499129632	200x5000	110	5072	237	152	62	90	5032	197	2536
670DH060-30BA	5705499129656	200x6000	110	6088	237	152	62	90	6048	197	3044

670DK010-05BA	5705499129663	200x1000	160	1040	237	170	80	90	1000	197	520
670DK015-08BA	5705499129670	200x1500	160	1540	237	170	80	90	1500	197	770
670DK020-10BA	5705499129687	200x2000	160	2040	237	170	80	90	2000	197	1020
670DK030-15BA	5705499129694	200x3000	160	3056	237	170	80	90	3016	197	1528
670DK040-20BA	5705499129717	200x4000	160	4072	237	170	80	90	4032	197	2036
670DK050-25BA	5705499129731	200x5000	160	5072	237	170	80	90	5032	197	2536
670DK060-30BA	5705499129755	200x6000	160	6088	237	170	80	90	6048	197	3044

670EK010-05BA	5705499129779	300x1000	160	1040	337	170	80	90	1000	297	520
670EK015-08BA	5705499129816	300x1500	160	1540	337	170	80	90	1500	297	770
670EK020-10BA	5705499129830	300x2000	160	2040	337	170	80	90	2000	297	1020
670EK030-15BA	5705499129854	300x3000	160	3056	337	170	80	90	3016	297	1528
670EK040-20BA	5705499129878	300x4000	160	4072	337	170	80	90	4032	297	2036
670EK050-25BA	5705499129892	300x5000	160	5072	337	170	80	90	5032	297	2536
670EK060-30BA	5705499129915	300x6000	160	6088	337	170	80	90	6048	297	3044

670FK010-05BA	5705499129939	400x1000	160	1040	437	170	80	90	1000	397	520
670FK015-08BA	5705499129953	400x1500	160	1540	437	170	80	90	1500	397	770
670FK020-10BA	5705499129977	400x2000	160	2040	437	170	80	90	2000	397	1020
670FK030-15BA	5705499129991	400x3000	160	3056	437	170	80	90	3016	397	1528
670FK040-20BA	5705499130010	400x4000	160	4072	437	170	80	90	4032	397	2036
670FK050-25BA	5705499130034	400x5000	160	5072	437	170	80	90	5032	397	2536
670FK060-30BA	5705499130058	400x6000	160	6088	437	170	80	90	6048	397	3044

without membrane

CHANNEL TYPE 671

END OUTLET, WITH OUTLET BOX

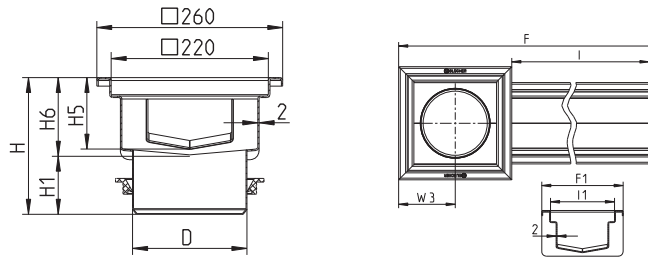

Type no.	EAN no.	Name	D	F	F1	H	H1	H5	H6	I	I1	W3
671CK010-00BA	5705499125818	150x1000	160	1280	187	180	80	90	100	1000	147	130
671CK015-00BA	5705499125825	150x1500	160	1780	187	180	80	90	100	1500	147	130
671CK020-00BA	5705499125832	150x2000	160	2280	187	180	80	90	100	2000	147	130
671CK030-00BA	5705499125849	150x3000	160	3296	187	180	80	90	100	3016	147	130
671CK040-00BA	5705499130089	150x4000	160	4304	187	205	80	120	125	4024	147	130
671CK050-00BA	5705499130102	150x5000	160	5312	187	205	80	120	125	5032	147	130
671CK060-00BA	5705499130126	150x6000	160	6320	187	205	80	120	125	6040	147	130

CHANNEL TYPE 671

CENTER OUTLET, WITH OUTLET BOX

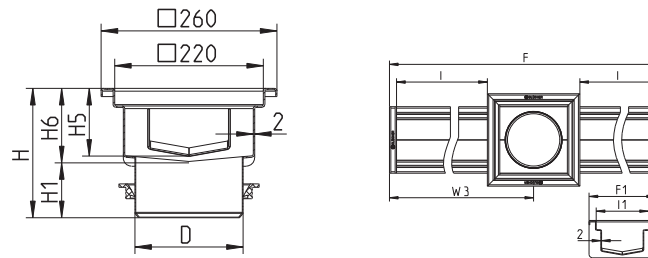

Type no.	EAN no.	Name	D	F	F1	H	H1	H5	H6	I	I1	W3
671CK020-10BA	5705499130065	150x2000	160	2300	187	180	80	90	100	1000	147	1150
671CK030-15BA	5705499130072	150x3000	160	3300	187	180	80	90	100	1500	147	1650
671CK040-20BA	5705499130096	150x4000	160	4300	187	180	80	90	100	2000	147	2150
671CK050-25BA	5705499130119	150x5000	160	5332	187	180	80	90	100	2516	147	2666
671CK060-30BA	5705499130133	150x6000	160	6332	187	180	80	90	100	3016	147	3166

without membrane

SLOT CHANNEL TYPE 673

END OUTLET, WITH OUTLET BOX

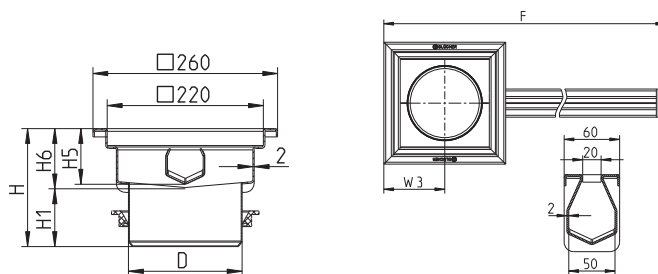

Type no.	EAN no.	Name	D	F	H	H1	H5	H6	W3
673AK010-00BA	5705499130751	20x1000	160	1000	165	80	78	85	130
673AK015-00BA	5705499130768	20x1500	160	1500	165	80	78	85	130
673AK020-00BA	5705499130775	20x2000	160	2000	165	80	78	85	130
673AK030-00BA	5705499130799	20x3000	160	3000	165	80	78	85	130

SLOT CHANNEL TYPE 673

CENTER OUTLET, WITH OUTLET BOX

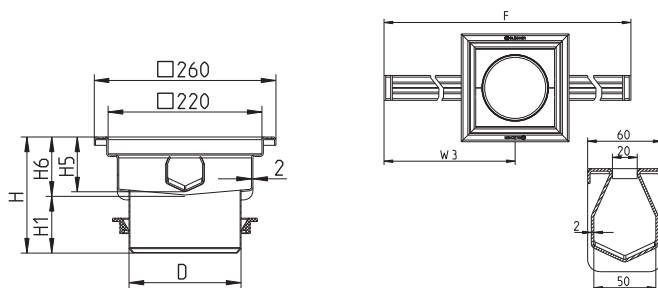

Type no.	EAN no.	Name	D	F	H	H1	H5	H6	W3
673AK020-10BA	5705499130782	20x2000	160	2000	165	80	78	85	1000
673AK030-15BA	5705499125856	20x3000	160	3000	165	80	78	85	1500
673AK040-20BA	5705499125863	20x4000	160	4000	165	80	78	85	2000
673AK050-25BA	5705499125870	20x5000	160	5000	165	80	78	85	2500
673AK060-30BA	5705499125887	20x6000	160	6000	165	80	78	85	3000
673AK070-35BA	5705499125894	20x7000	160	7000	180	80	93	100	3500
673AK080-40BA	5705499125900	20x8000	160	8000	180	80	93	100	4000
673AK090-45BA	5705499125917	20x9000	160	9000	180	80	93	100	4500
673AK100-50BA	5705499125924	20x10000	160	10000	180	80	93	100	5000
673AK110-55BA	5705499125931	20x11000	160	11000	180	80	93	100	5500
673AK120-60BA	5705499125948	20x12000	160	12000	200	80	108	120	6000

without membrane

HYGIENICPRO CHANNEL TYPE 676

END OUTLET

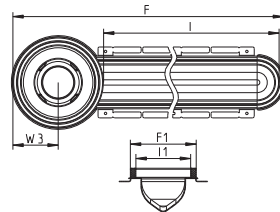
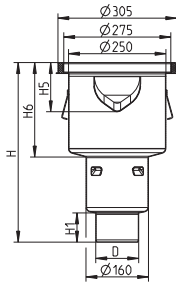

Type no.	EAN no.	D	F	F1	H	H1	H5	H6	I	I1	W3
676CC010-00CF	5705499135497	110	1393	177	378	75	126	160	1074	147	152
676CC010-00DF	5705499135510	110	1393	177	460	75	126	242	1074	147	152
676CC010-00EF	5705499135534	110	1393	177	545	75	126	327	1074	147	152
676CC015-00CF	5705499135619	110	1893	177	378	75	126	160	1574	147	152
676CC015-00DF	5705499135633	110	1893	177	460	75	126	242	1574	147	152
676CC015-00EF	5705499135657	110	1893	177	545	75	126	327	1574	147	152
676CC020-00CF	5705499135732	110	2393	177	378	75	126	160	2074	147	152
676CC020-00DF	5705499135756	110	2393	177	460	75	126	242	2074	147	152
676CC020-00EF	5705499135770	110	2393	177	545	75	126	327	2074	147	152
676CC030-00CF	5705499135978	110	3409	177	398	75	146	180	3090	147	152
676CC030-00DF	5705499135992	110	3409	177	480	75	146	262	3090	147	152
676CC030-00EF	5705499136012	110	3409	177	565	75	146	347	3090	147	152
676CC040-00CF	5705499136210	110	4417	177	398	75	146	180	4098	147	152
676CC040-00DF	5705499136234	110	4417	177	480	75	146	262	4098	147	152
676CC040-00EF	5705499136258	110	4417	177	565	75	146	347	4098	147	152
676CC050-00CF	5705499136456	110	5425	177	398	75	146	180	5106	147	152
676CC050-00DF	5705499136470	110	5425	177	480	75	146	262	5106	147	152
676CC050-00EF	5705499136494	110	5425	177	565	75	146	347	5106	147	152

HYGIENICPRO CHANNEL TYPE 676

CENTER OUTLET

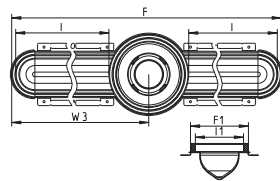
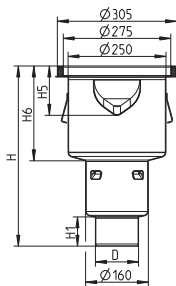

Type no.	EAN no.	D	F	F1	H	H1	H5	H6	I	I1	W3
676CC010-05CF	5705499136579	110	1482	177	378	75	126	160	574	147	741
676CC010-05DF	5705499136593	110	1482	177	460	75	126	242	574	147	741
676CC010-05EF	5705499136616	110	1482	177	545	75	126	327	574	147	741
676CC020-10CF	5705499136692	110	2482	177	378	75	126	160	1074	147	1241
676CC020-10DF	5705499136715	110	2482	177	460	75	126	242	1074	147	1241
676CC020-10EF	5705499136739	110	2482	177	545	75	126	327	1074	147	1241
676CC030-15CF	5705499136814	110	3482	177	378	75	126	160	1574	147	1741
676CC030-15DF	5705499136838	110	3482	177	460	75	126	242	1574	147	1741
676CC030-15EF	5705499136852	110	3482	177	545	75	126	327	1574	147	1741
676CC040-20CF	5705499136937	110	4482	177	378	75	126	160	2074	147	2241
676CC040-20DF	5705499136951	110	4482	177	460	75	126	242	2074	147	2241
676CC040-20EF	5705499136975	110	4482	177	545	75	126	327	2074	147	2241
676CC050-25CF	5705499137057	110	5514	177	378	75	126	160	2590	147	2757
676CC050-25DF	5705499137071	110	5514	177	460	75	126	242	2590	147	2757
676CC050-25EF	5705499137095	110	5514	177	545	75	126	327	2590	147	2757
676CC060-30CF	5705499137170	110	6516	177	398	75	146	180	3091	147	3258

Continues on next page

All dimensions in mm - Stainless Steel grade AISI 316L specify type no. with suffix S

without membrane

HYGIENICPRO CHANNEL TYPE 676

Type no.	EAN no.	D	F	F1	H	H1	H5	H6	I	I1	W3
Continued from previous page											
676CC060-30DF	5705499137194	110	6516	177	480	75	146	262	3091	147	3258
676CC060-30EF	5705499137217	110	6516	177	565	75	146	347	3091	147	3258
676CC070-35CF	5705499137293	110	7532	177	398	75	146	180	3599	147	3766
676CC070-35DF	5705499137316	110	7532	177	480	75	146	262	3599	147	3766
676CC070-35EF	5705499137330	110	7532	177	565	75	146	347	3599	147	3766
676CC080-40CF	5705499137415	110	8532	177	398	75	146	180	4099	147	4266
676CC080-40DF	5705499137439	110	8532	177	480	75	146	262	4099	147	4266
676CC080-40EF	5705499137453	110	8532	177	565	75	146	347	4099	147	4266
676CC090-45CF	5705499137545	110	9548	177	398	75	146	180	4607	147	4774
676CC090-45DF	5705499137569	110	9548	177	480	75	146	262	4607	147	4774
676CC090-45EF	5705499137583	110	9548	177	565	75	146	347	4607	147	4774
676CC100-50CF	5705499137668	110	10548	177	398	75	146	180	5107	147	5274
676CC100-50DF	5705499137682	110	10548	177	480	75	146	262	5107	147	5274
676CC100-50EF	5705499137705	110	10548	177	565	75	146	347	5107	147	5274

HYGIENICPRO CHANNEL TYPE 676

CENTER OUTLET

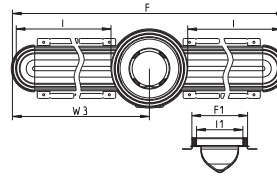
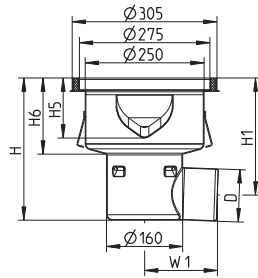

Type no.	EAN no.	D	F	F1	H	H1	H5	H6	I	I1	W1	W3
676CT010-05CF	5705499136630	110	1482	177	299	246	126	160	574	147	153	741
676CT020-10CF	5705499136753	110	2482	177	299	246	126	160	1074	147	153	1241
676CT030-15CF	5705499136876	110	3482	177	299	246	126	160	1574	147	153	1741
676CT040-20CF	5705499136999	110	4482	177	299	246	126	160	2074	147	153	2241
676CT050-25CF	5705499137118	110	5514	177	299	246	126	160	2590	147	153	2757
676CT060-30CF	5705499137231	110	6516	177	319	266	146	180	3091	147	153	3258
676CT070-35CF	5705499137354	110	7392	177	319	266	146	180	3529	147	153	3696
676CT080-40CF	5705499137484	110	8532	177	319	266	146	180	4099	147	153	4266
676CT090-45CF	5705499137606	110	9548	177	319	266	146	180	4607	147	153	4774
676CT100-50CF	5705499137729	110	10548	177	319	266	146	180	5107	147	153	5274

with liquid membrane

CHANNEL TYPE 674

END OUTLET

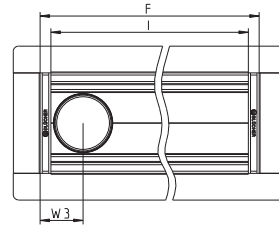
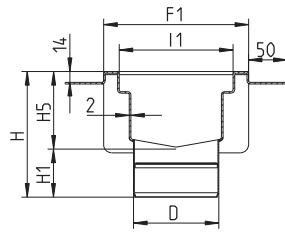

Type no.	EAN no.	Name	D	F	F1	H	H1	H5	I	I1	W3
674CH009-00BA	5705499135060	150x900	110	940	187	152	62	90	900	147	80
674CH010-00BA	5705499131758	150x1000	110	1040	187	152	62	90	1000	147	80
674CH011-00BA	5705499135077	150x1100	110	1140	187	152	62	90	1100	147	80
674CH012-00BA	5705499135084	150x1200	110	1240	187	152	62	90	1200	147	80
674CH014-00BA	5705499135091	150x1400	110	1440	187	152	62	90	1400	147	80
674CH015-00BA	5705499130812	150x1500	110	1540	187	152	62	90	1500	147	80
674CH020-00BA	5705499130836	150x2000	110	2040	187	152	62	90	2000	147	80
674CH030-00BA	5705499130850	150x3000	110	3056	187	152	62	90	3016	147	80
674CH040-00BA	5705499130874	150x4000	110	4072	187	182	62	120	4032	147	80
674CH050-00BA	5705499130898	150x5000	110	5072	187	182	62	120	5032	147	80
674CH060-00BA	5705499130911	150x6000	110	6088	187	182	62	120	6048	147	80

674DH010-00BA	5705499130935	200x1000	110	1040	237	152	62	90	1000	197	80
674DH015-00BA	5705499130959	200x1500	110	1540	237	152	62	90	1500	197	80
674DH020-00BA	5705499130973	200x2000	110	2040	237	152	62	90	2000	197	80
674DH030-00BA	5705499130997	200x3000	110	3056	237	152	62	90	3016	197	80
674DH040-00BA	5705499131017	200x4000	110	4072	237	182	62	120	4032	197	80
674DH050-00BA	5705499131031	200x5000	110	5072	237	182	62	120	5032	197	80
674DH060-00BA	5705499131062	200x6000	110	6088	237	182	62	120	6048	197	80

674DK010-00BA	5705499131086	200x1000	160	1040	237	170	80	90	1000	197	105
674DK015-00BA	5705499131109	200x1500	160	1540	237	170	80	90	1500	197	105
674DK020-00BA	5705499131123	200x2000	160	2040	237	170	80	90	2000	197	105
674DK030-00BA	5705499131215	200x3000	160	3056	237	170	80	90	3016	197	105
674DK040-00BA	5705499131154	200x4000	160	4072	237	200	80	120	4032	197	105
674DK050-00BA	5705499131178	200x5000	160	5072	237	200	80	120	5032	197	105
674DK060-00BA	5705499131192	200x6000	160	6088	237	200	80	120	6048	197	105

674EK010-00BA	5705499131222	300x1000	160	1040	337	170	80	90	1000	297	105
674EK015-00BA	5705499131246	300x1500	160	1540	337	170	80	90	1500	297	105
674EK020-00BA	5705499131260	300x2000	160	2040	337	170	80	90	2000	297	105
674EK030-00BA	5705499131284	300x3000	160	3056	337	170	80	90	3016	297	105
674EK040-00BA	5705499131307	300x4000	160	4072	337	200	80	120	4032	297	105
674EK050-00BA	5705499131321	300x5000	160	5072	337	200	80	120	5032	297	105
674EK060-00BA	5705499131345	300x6000	160	6088	337	200	80	120	6048	297	105

674FK010-00BA	5705499131369	400x1000	160	1040	437	170	80	90	1000	397	105
674FK015-00BA	5705499131383	400x1500	160	1540	437	170	80	90	1500	397	105
674FK020-00BA	5705499131406	400x2000	160	2040	437	170	80	90	2000	397	105
674FK030-00BA	5705499131420	400x3000	160	3056	437	170	80	90	3016	397	105
674FK040-00BA	5705499131444	400x4000	160	4072	437	200	80	120	4032	397	105
674FK050-00BA	5705499131468	400x5000	160	5072	437	200	80	120	5032	397	105
674FK060-00BA	5705499131482	400x6000	160	6088	437	200	80	120	6048	397	105

with liquid membrane

CHANNEL TYPE 674

CENTER OUTLET

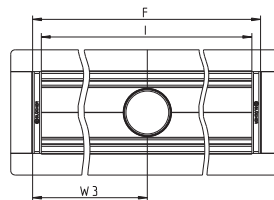
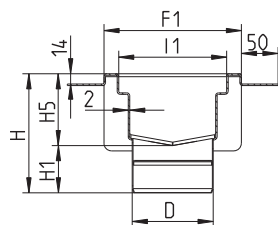

Type no.	EAN no.	Name	D	F	F1	H	H1	H5	I	I1	W3
674CH010-05BA	5705499130805	150x1000	110	1040	187	152	62	90	1000	147	520
674CH015-08BA	5705499130829	150x1500	110	1540	187	152	62	90	1500	147	770
674CH020-10BA	5705499130843	150x2000	110	2040	187	152	62	90	2000	147	1020
674CH030-15BA	5705499130867	150x3000	110	3056	187	152	62	90	3016	147	1528
674CH040-20BA	5705499130881	150x4000	110	4072	187	152	62	90	4032	147	2036
674CH050-25BA	5705499130904	150x5000	110	5072	187	152	62	90	5032	147	2536
674CH060-30BA	5705499130928	150x6000	110	6088	187	152	62	90	6048	147	3044

674DH010-05BA	5705499130942	200x1000	110	1040	237	152	62	90	1000	197	520
674DH015-08BA	5705499130966	200x1500	110	1540	237	152	62	90	1500	197	770
674DH020-10BA	5705499130980	200x2000	110	2040	237	152	62	90	2000	197	1020
674DH030-15BA	5705499131000	200x3000	110	3056	237	152	62	90	3016	197	1528
674DH040-20BA	5705499131024	200x4000	110	4072	237	152	62	90	4032	197	2036
674DH050-25BA	5705499131055	200x5000	110	5072	237	152	62	90	5032	197	2536
674DH060-30BA	5705499131079	200x6000	110	6088	237	152	62	90	6048	197	3044

674DK010-05BA	5705499131093	200x1000	160	1040	237	170	80	90	1000	197	520
674DK015-08BA	5705499131116	200x1500	160	1540	237	170	80	90	1500	197	770
674DK020-10BA	5705499131130	200x2000	160	2040	237	170	80	90	2000	197	1020
674DK030-15BA	5705499131147	200x3000	160	3056	237	170	80	90	3016	197	1528
674DK040-20BA	5705499131161	200x4000	160	4072	237	170	80	90	4032	197	2036
674DK050-25BA	5705499131185	200x5000	160	5072	237	170	80	90	5032	197	2536
674DK060-30BA	5705499131208	200x6000	160	6088	237	170	80	90	6048	197	3044

674EK010-05BA	5705499131239	300x1000	160	1040	337	170	80	90	1000	297	520
674EK015-08BA	5705499131253	300x1500	160	1540	337	170	80	90	1500	297	770
674EK020-10BA	5705499131277	300x2000	160	2040	337	170	80	90	2000	297	1020
674EK030-15BA	5705499131291	300x3000	160	3056	337	170	80	90	3016	297	1528
674EK040-20BA	5705499131314	300x4000	160	4072	337	170	80	90	4032	297	2036
674EK050-25BA	5705499131338	300x5000	160	5072	337	170	80	90	5032	297	2536
674EK060-30BA	5705499131352	300x6000	160	6088	337	170	80	90	6048	297	3044

674FK010-05BA	5705499131376	400x1000	160	1040	437	170	80	90	1000	397	520
674FK015-08BA	5705499131390	400x1500	160	1540	437	170	80	90	1500	397	770
674FK020-10BA	5705499131413	400x2000	160	2040	437	170	80	90	2000	397	1020
674FK030-15BA	5705499131437	400x3000	160	3056	437	170	80	90	3016	397	1528
674FK040-20BA	5705499131451	400x4000	160	4072	437	170	80	90	4032	397	2036
674FK050-25BA	5705499131475	400x5000	160	5072	437	170	80	90	5032	397	2536
674FK060-30BA	5705499131499	400x6000	160	6088	437	170	80	90	6048	397	3044

with liquid membrane

SLOT CHANNEL TYPE 677

END OUTLET

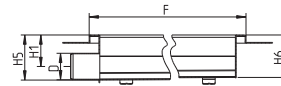
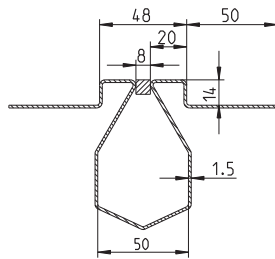

Type no.	EAN no.	Name	D	F	H1	H5	H6
677AN010-00BA	5705499128246	8x1000	50	1000	60	85	80
677AN015-00BA	5705499128260	8x1500	50	1500	60	85	77
677AN020-00BA	5705499128284	8x2000	50	2000	60	85	75
677AN030-00BA	5705499128307	8x3000	50	3000	60	85	70

CHANNEL TYPE 678

END OUTLET

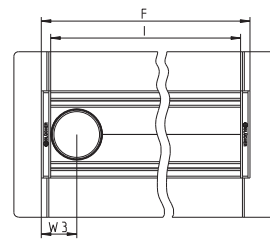
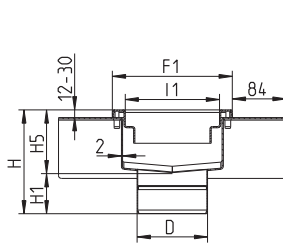

Type no.	EAN no.	Name	D	F	F1	H	H1	H5	I	I1	W3
678CH009-00BA	5705499135121	150x900	110	940	187	162-180	62	100-118	900	147	76
678CH010-00BA	5705499135138	150x1000	110	1040	187	162-180	62	100-118	1000	147	76
678CH011-00BA	5705499135145	150x1100	110	1140	187	162-180	62	100-118	1100	147	76
678CH012-00BA	5705499135152	150x1200	110	1240	187	162-180	62	100-118	1200	147	76
678CH014-00BA	5705499135169	150x1400	110	1440	187	162-180	62	100-118	1400	147	76

CHANNEL TYPE 672

END OUTLET

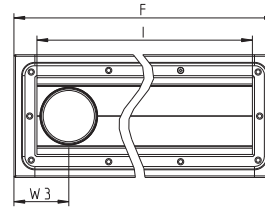
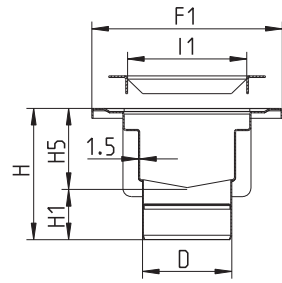

Type no.	EAN no.	Name	D	F	F1	H	H1	H5	I	I1	W3
672CH009-00BA	5705499124224	150x900	110	988	235	152	62	90	900	147	105
672CH010-00BA	5705499124798	150x1000	110	1088	235	152	62	90	1000	147	105
672CH011-00BA	5705499135053	150x1100	110	1188	235	152	62	90	1100	147	105
672CH012-00BA	5705499124231	150x1200	110	1288	235	152	62	90	1200	147	105
672CH014-00BA	5705499124248	150x1400	110	1488	235	152	62	90	1400	147	105
672CH015-00BA	5705499124804	150x1500	110	1588	235	152	62	90	1500	147	105
672CH020-00BA	5705499124811	150x2000	110	2088	235	152	62	90	2000	147	105
672CH030-00BA	5705499124828	150x3000	110	3104	235	152	62	90	3016	147	105
672CH040-00BA	5705499130188	150x4000	110	4120	235	182	62	120	4032	147	105
672CH050-00BA	5705499130201	150x5000	110	5120	235	182	62	120	5032	147	105
672CH060-00BA	5705499130225	150x6000	110	6136	235	182	62	120	6048	147	105

672DH010-00BA	5705499130249	200x1000	110	1088	285	152	62	90	1000	197	105
672DH015-00BA	5705499130263	200x1500	110	1588	285	152	62	90	1500	197	105
672DH020-00BA	5705499130287	200x2000	110	2088	285	152	62	90	2000	197	105
672DH030-00BA	5705499130300	200x3000	110	3104	285	152	62	90	3016	197	105
672DH040-00BA	5705499130324	200x4000	110	4120	285	182	62	120	4032	197	105
672DH050-00BA	5705499130348	200x5000	110	5120	285	182	62	120	5032	197	105
672DH060-00BA	5705499130362	200x6000	110	6136	285	182	62	120	6048	197	105

672DK010-00BA	5705499124835	200x1000	160	1088	285	170	80	90	1000	197	130
672DK015-00BA	5705499124842	200x1500	160	1588	285	170	80	90	1500	197	130
672DK020-00BA	5705499124859	200x2000	160	2088	285	170	80	90	2000	197	130
672DK030-00BA	5705499124866	200x3000	160	3104	285	170	80	90	3016	197	130
672DK040-00BA	5705499130423	200x4000	160	4120	285	200	80	120	4032	197	130
672DK050-00BA	5705499130447	200x5000	160	5120	285	200	80	120	5032	197	130
672DK060-00BA	5705499130461	200x6000	160	6136	285	200	80	120	6048	197	130

672EK010-00BA	5705499130485	300x1000	160	1088	385	170	80	90	1000	297	130
672EK015-00BA	5705499130492	300x1500	160	1588	385	170	80	90	1500	297	130
672EK020-00BA	5705499130508	300x2000	160	2088	385	170	80	90	2000	297	130
672EK030-00BA	5705499130515	300x3000	160	3104	385	170	80	90	3016	297	130
672EK040-00BA	5705499130522	300x4000	160	4120	385	200	80	120	4032	297	130
672EK050-00BA	5705499130553	300x5000	160	5120	385	200	80	120	5032	297	130
672EK060-00BA	5705499130584	300x6000	160	6136	385	200	80	120	6048	297	130

672FK010-00BA	5705499130607	400x1000	160	1088	485	170	80	90	1000	397	130
672FK015-00BA	5705499130621	400x1500	160	1588	485	170	80	90	1500	397	130
672FK020-00BA	5705499130645	400x2000	160	2088	485	170	80	90	2000	397	130
672FK030-00BA	5705499130669	400x3000	160	3104	485	170	80	90	3016	397	130
672FK040-00BA	5705499130683	400x4000	160	4120	485	200	80	120	4032	397	130
672FK050-00BA	5705499130713	400x5000	160	5120	485	200	80	120	5032	397	130
672FK060-00BA	5705499130737	400x6000	160	6136	485	200	80	120	6048	397	130

CHANNEL TYPE 672

CENTER OUTLET

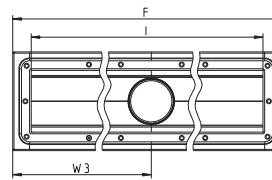
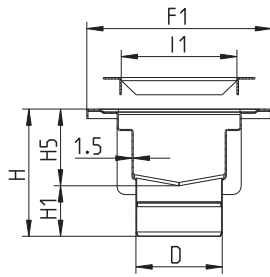

Type no.	EAN no.	Name	D	F	F1	H	H1	H5	I	I1	W3
672CH010-05BA	5705499130140	150x1000	110	1088	235	152	62	90	1000	147	544
672CH015-08BA	5705499130157	150x1500	110	1588	235	152	62	90	1500	147	794
672CH020-10BA	5705499130164	150x2000	110	2088	235	152	62	90	2000	147	1044
672CH030-15BA	5705499130171	150x3000	110	3104	235	152	62	90	3016	147	1552
672CH040-20BA	5705499130195	150x4000	110	4120	235	152	62	90	4032	147	2060
672CH050-25BA	5705499130218	150x5000	110	5120	235	152	62	90	5032	147	2560
672CH060-30BA	5705499130232	150x6000	110	6136	235	152	62	90	6048	147	3068

672DH010-05BA	5705499130256	200x1000	110	1088	285	152	62	90	1000	197	544
672DH015-08BA	5705499130270	200x1500	110	1588	285	152	62	90	1500	197	794
672DH020-10BA	5705499130294	200x2000	110	2088	285	152	62	90	2000	197	1044
672DH030-15BA	5705499130317	200x3000	110	3104	285	152	62	90	3016	197	1552
672DH040-20BA	5705499130331	200x4000	110	4120	285	152	62	90	4032	197	2060
672DH050-25BA	5705499130355	200x5000	110	5120	285	152	62	90	5032	197	2560
672DH060-30BA	5705499130379	200x6000	110	6136	285	152	62	90	6048	197	3068

672DK010-05BA	5705499130386	200x1000	160	1088	285	170	80	90	1000	197	544
672DK015-08BA	5705499130393	200x1500	160	1588	285	170	80	90	1500	197	794
672DK020-10BA	5705499130409	200x2000	160	2088	285	170	80	90	2000	197	1044
672DK030-15BA	5705499130416	200x3000	160	3104	285	170	80	90	3016	197	1552
672DK040-20BA	5705499130430	200x4000	160	4120	285	170	80	90	4032	197	2060
672DK050-25BA	5705499130454	200x5000	160	5120	285	170	80	90	5032	197	2560
672DK060-30BA	5705499130478	200x6000	160	6136	285	170	80	90	6048	197	3068

672EK010-05BA	5705499124873	300x1000	160	1088	385	170	80	90	1000	297	544
672EK015-08BA	5705499124880	300x1500	160	1588	385	170	80	90	1500	297	794
672EK020-10BA	5705499124897	300x2000	160	2088	385	170	80	90	2000	297	1044
672EK030-15BA	5705499124903	300x3000	160	3104	385	170	80	90	3016	297	1552
672EK040-20BA	5705499130546	300x4000	160	4120	385	170	80	90	4032	297	2060
672EK050-25BA	5705499130577	300x5000	160	5120	385	170	80	90	5032	297	2560
672EK060-30BA	5705499130591	300x6000	160	6136	385	170	80	90	6048	297	3068

672FK010-05BA	5705499130614	400x1000	160	1088	485	170	80	90	1000	397	544
672FK015-08BA	5705499130638	400x1500	160	1588	485	170	80	90	1500	397	794
672FK020-10BA	5705499130652	400x2000	160	2088	485	170	80	90	2000	397	1044
672FK030-15BA	5705499130676	400x3000	160	3104	485	170	80	90	3016	397	1552
672FK040-20BA	5705499130706	400x4000	160	4120	485	170	80	90	4032	397	2060
672FK050-25BA	5705499130720	400x5000	160	5120	485	170	80	90	5032	397	2560
672FK060-30BA	5705499130744	400x6000	160	6136	485	170	80	90	6048	397	3068

without membrane

KITCHEN CHANNEL TYPE 660

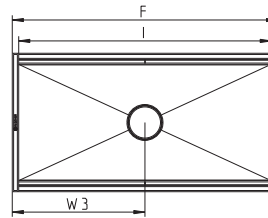
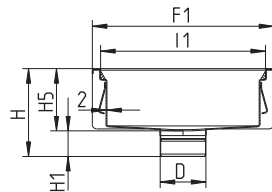

Type no.	EAN no.	Name	D	F	F1	H	H1	H5	I	I1	W3
660EK005-11	5705499134735	300x500	160	540	337	195	85	110	500	297	270
660FH004-06	5705499126174	400x400	110	437	437	121	61	60	397	397	218
660FH004-11	5705499126181	400x400	110	437	437	171	61	110	397	397	218
660FH004-15	5705499126198	400x400	110	437	437	211	61	150	397	397	218
660FH008-06	5705499126204	400x800	110	837	437	121	61	60	797	397	418
660FH008-11	5705499126211	400x800	110	837	437	171	61	110	797	397	418
660FH008-15	5705499126228	400x800	110	837	437	211	61	150	797	397	418
660FK004-06	5705499126235	400x400	160	437	437	145	85	60	397	397	218
660FK004-11	5705499126242	400x400	160	437	437	195	85	110	397	397	218
660FK004-15	5705499126259	400x400	160	437	437	235	85	150	397	397	218
660FK006-11	5705499126266	400x600	160	637	437	195	85	110	597	397	318
660FK008-06	5705499126273	400x800	160	837	437	145	85	60	797	397	418
660FK008-11	5705499126280	400x800	160	837	437	195	85	110	797	397	418
660FK008-15	5705499126297	400x800	160	837	437	235	85	150	797	397	418
660GH005-06	5705499126303	500x500	110	537	537	121	61	60	497	497	268
660GH005-11	5705499126310	500x500	110	537	537	171	61	110	497	497	268
660GH005-15	5705499126327	500x500	110	537	537	211	61	150	497	497	268
660GH008-15	5705499134520	500x800	110	837	537	211	61	150	797	497	418
660GH010-06	5705499127874	500x1000	110	1037	537	121	61	60	997	497	518
660GH010-11	5705499127881	500x1000	110	1037	537	171	61	110	997	497	518
660GH010-15	5705499126334	500x1000	110	1037	537	211	61	150	997	497	518
660GK005-06	5705499126341	500x500	160	537	537	145	85	60	497	497	268
660GK005-11	5705499126358	500x500	160	537	537	195	85	110	497	497	268
660GK005-15	5705499126365	500x500	160	537	537	235	85	150	497	497	268
660GK010-06	5705499126372	500x1000	160	1037	537	145	85	60	997	497	518
660GK010-11	5705499126389	500x1000	160	1037	537	195	85	110	997	497	518
660GK010-15	5705499126396	500x1000	160	1037	537	235	85	150	997	497	518
660HK009-11	5705499134742	600x900	160	937	637	195	85	110	897	597	468

with liquid membrane

KITCHEN CHANNEL TYPE 664

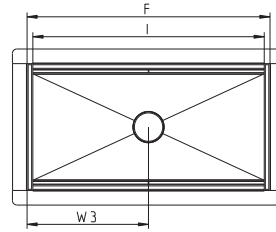
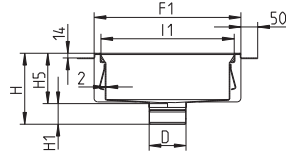

Type no.	EAN no.	Name	D	F	F1	H	H1	H5	I	I1	W3
664EK005-11	5705499134766	300x500	160	540	337	195	85	110	500	297	270
664FH004-15	5705499126013	400x400	110	437	437	211	61	150	397	397	218
664FH008-15	5705499126020	400x800	110	837	437	211	61	150	797	397	418
664FK004-06	5705499126037	400x400	160	437	437	145	85	60	397	397	218
664FK004-11	5705499126044	400x400	160	437	437	195	85	110	397	397	218
664FK004-15	5705499126051	400x400	160	437	437	235	85	150	397	397	218
664FK008-06	5705499126075	400x800	160	837	437	145	85	60	797	397	418
664FK008-15	5705499131895	400x800	160	837	437	235	85	150	797	397	418
664GH005-15	5705499126082	500x500	110	537	537	211	61	150	497	497	268
664GH010-15	5705499126099	500x1000	110	1037	537	211	61	150	997	497	518
664GK005-06	5705499126105	500x500	160	537	537	145	85	60	497	497	268
664GK005-11	5705499134773	500x500	160	537	537	195	85	110	497	497	268
664GK005-15	5705499126112	500x500	160	537	537	235	85	150	497	497	268
664GK008-11	5705499135107	500x800	160	837	537	195	85	110	797	497	418
664GK010-06	5705499126129	500x1000	160	1037	537	145	85	60	997	497	518
664GK010-11	5705499134780	500x1000	160	1037	537	195	85	110	997	497	518
664GK010-15	5705499127867	500x1000	160	1037	537	235	85	150	997	497	518
664HK009-11	5705499135114	600x900	160	937	637	195	85	110	897	597	468

KITCHEN CHANNEL TYPE 668

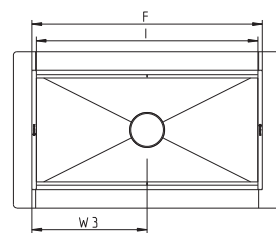
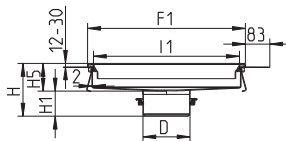

Type no.	EAN no.	Name	D	F	F1	H	H1	H5	I	I1	W3
668EK005-11	5705499134902	300x500	160	540	337	179-197	85	94-112	500	297	270
668FK004-11	5705499135176	400x400	160	437	437	179-197	85	94-112	397	397	218
668FK006-11	5705499135183	400x600	160	637	437	179-197	85	94-112	597	397	318
668GK005-11	5705499134919	500x500	160	537	537	179-197	85	94-112	497	497	268
668GK008-11	5705499135190	500x800	160	837	537	179-197	85	94-112	797	497	418
668GK010-11	5705499134926	500x1000	160	1037	537	179-197	85	94-112	997	497	518
668HK009-11	5705499135206	600x900	160	937	637	179-197	85	94-112	897	597	468

with liquid membrane

KITCHEN CHANNEL TYPE 668

SQUARE

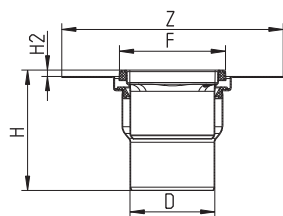

Type no.	EAN no.	Name	D	F	Z	H	H2
668DK002-00	5705499134698	200x200	160	200x200	418x418	227-245	12-30
668EK003-00	5705499134704	300x300	160	311x311	477x477	155-173	12-30

KITCHEN CHANNEL TYPE 662

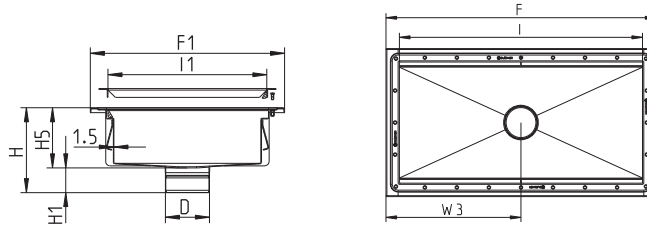

Type no.	EAN no.	Name	D	F	F1	H	H1	H5	I	I1	W3
662EK005-11	5705499134759	300x500	160	588	385	195	85	110	500	297	294
662FH004-06	5705499126433	400x400	110	485	485	121	61	60	397	397	242
662FH004-15	5705499126440	400x400	110	485	485	211	61	150	397	397	242
662FH008-06	5705499126457	400x800	110	885	485	121	61	60	797	397	442
662FH008-15	5705499126464	400x800	110	885	485	211	61	150	797	397	442
662FK004-06	5705499126471	400x400	160	485	485	145	85	60	397	397	242
662FK004-11	5705499126488	400x400	160	485	485	195	85	110	397	397	242
662FK004-15	5705499126495	400x400	160	485	485	235	85	150	397	397	242
662FK006-11	5705499126501	400x600	160	685	485	195	85	110	597	397	343
662FK008-06	5705499126518	400x800	160	885	485	145	85	60	797	397	442
662FK008-15	5705499126525	400x800	160	885	485	235	85	150	797	397	442
662GH005-06	5705499126532	500x500	110	585	585	121	61	60	497	497	292
662GH005-15	5705499126549	500x500	110	585	585	211	61	150	497	497	292
662GH008-15	5705499134537	500x800	110	885	585	211	61	150	797	497	442
662GH010-06	5705499126556	500x1000	110	1085	585	121	61	60	997	497	542
662GH010-15	5705499126563	500x1000	110	1085	585	211	61	150	997	497	542
662GK005-06	5705499131901	500x500	160	585	585	145	85	60	497	497	292
662GK005-15	5705499126587	500x500	160	585	585	235	85	150	497	497	292
662GK010-06	5705499126594	500x1000	160	1085	585	145	85	60	997	497	542
662GK010-15	5705499127850	500x1000	160	1085	585	235	85	150	997	497	542
662HK009-11	5705499126617	600x900	160	985	685	195	85	110	897	597	492

- without membrane flange

LOWER PART FOR CHANNEL AND KITCHEN CHANNEL TYPE 150

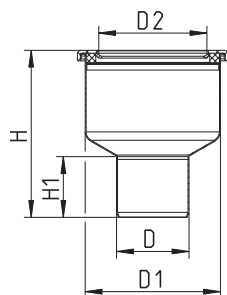

Type no.	EAN no.	D	D1	H	H1	D2
150.000.075	5705499107074	75	140	173	63	113
150.000.110	5705499107098	110	140	141	79	113

LOWER PART FOR CHANNEL AND KITCHEN CHANNEL TYPE 760.16

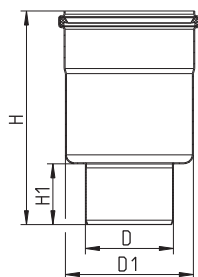

Type no.	EAN no.	D	D1	H	H1
760.160.075	5705499138016	75	160	256	65
760.160.110	5705499135343	110	160	267	76

LOWER PART FOR CHANNEL AND KITCHEN CHANNEL TYPE 110

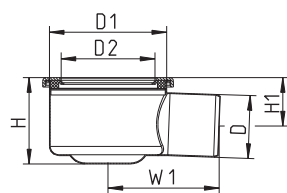

Type no.	EAN no.	D	D1	H	H1	W1	D2
110.000.075	5705499107036	75	140	103	58	133	113
110.000.110	5705499129403	110	140	124	71	143	113

- without membrane flange

LOWER PART FOR CHANNEL AND KITCHEN CHANNEL TYPE 763.00

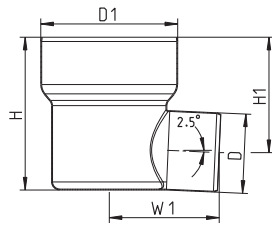

Type no.	EAN no.	D	D1	H	H1	W1
763.002.075	5705499109825	75	190	212	179	250
763.002.110	5705499109849	110	190	212	160	153

Sealing ring included with the upper part.
Drains with outlet other than D=110mm come fitted with adaptor.

LOWER PART FOR CHANNEL AND KITCHEN CHANNEL, LOW MODEL TYPE 763.042

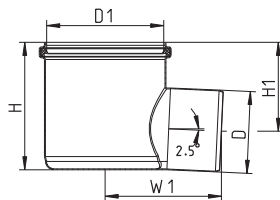

Type no.	EAN no.	D	D1	H	H1	W1
763.042.110	5705499131925	110	160	171	119	156

LOWER PART FOR CHANNEL AND KITCHEN CHANNEL TYPE 760.00

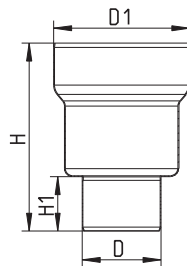

Type no.	EAN no.	D	D1	H	H1
760.002.075	5705499109269	75	190	267	65
760.002.110	5705499109283	110	190	278	76

Sealing ring included with the upper part.

- with liquid membrane flange

LOWER PART FOR CHANNEL AND KITCHEN CHANNEL TYPE 769.00

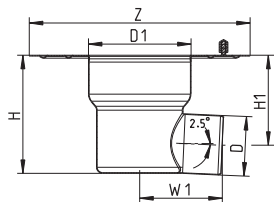

Type no.	EAN no.	D	D1	Z	H	H1	W1
769.002.075	5705499110869	75	190	Ø409	218	186	250
769.002.110	5705499110883	110	190	Ø409	218	166	153

Sealing ring included with the upper part.
Drains with outlet other than D=110mm come fitted with adaptor.

LOWER PART FOR CHANNEL AND KITCHEN CHANNEL TYPE 774.00

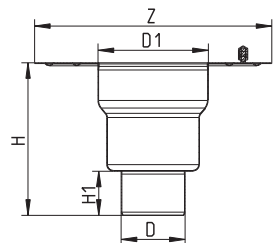

Type no.	EAN no.	D	D1	Z	H	H1
774.002.075	5705499111903	75	190	409	267	65
774.002.110	5705499111927	110	190	409	278	76

Sealing ring included with the upper part.

- with sheet membrane flange

LOWER PART FOR CHANNEL AND KITCHEN CHANNEL TYPE 771.00

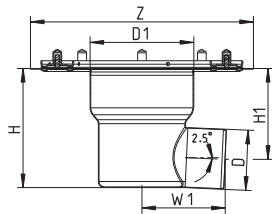

Type no.	EAN no.	D	D1	Z	H	H1	W1
771.002.075	5705499111224	75	190	Ø409	218	186	250
771.002.110	5705499111248	110	190	Ø409	218	166	153

Sealing ring included with the upper part.
Drains with outlet other than D=110mm come fitted with adaptor.

LOWER PART FOR CHANNEL AND KITCHEN CHANNEL TYPE 775.00

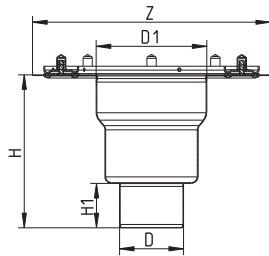

Type no.	EAN no.	D	D1	Z	H	H1
775.002.075	5705499112573	75	190	409	267	65
775.002.110	5705499112597	110	190	409	278	76

Sealing ring included with the upper part.

Gratings

SLOT GRATING CHANNEL

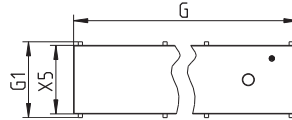
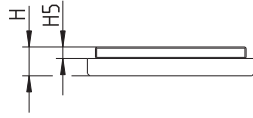

Type no.	EAN no.	Name	G	G1	H	H5	X5	EN1253 (kg)	EN1433 (kg)	Non slip
697.200.150.49	5705499124552	150x500	499	145	25	10	131	M125 (14.000)	A15 (3.000)	R10
697.200.150.99	5705499115499	150x1000	998	145	25	10	131	M125 (14.000)	A15 (3.000)	R10
697.200.200.50	5705499126884	200x500	499	195	25	10	181	N250 (20.000)	A15 (3.500)	R10
697.200.200.99	5705499115529	200x1000	998	195	25	10	181	N250 (20.000)	A15 (3.500)	R10
697.200.300.50	5705499131598	300x500	499	295	25	10	281	M125 (13.000)	A15 (3.500)	R10
697.200.300.99	5705499131604	300x1000	998	295	25	10	281	M125 (13.000)	A15 (3.500)	R10

MESH GRATING CHANNEL

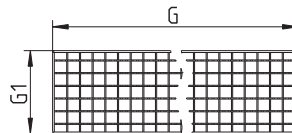
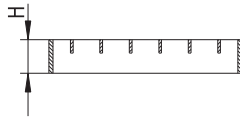

Type no.	EAN no.	Name	G	G1	H	EN1433 (kg)	Non slip
696.223.144.49	5705499124415	150x500	499	144	25	A15 (1.800)	R12
696.223.144.99	5705499124439	150x1000	998	144	25	A15 (1.800)	R12
696.223.194.49	5705499124477	200x500	499	194	25	A15 (1.350)	R12
696.223.194.99	5705499124491	200x1000	998	194	25	A15 (1.350)	R12
696.223.294.49	5705499131505	300x500	499	294	25	A15 (1.350)	R12
696.223.294.99	5705499131512	300x1000	998	294	25	A15 (1.350)	R12
696.223.394.49	5705499131529	400x500	499	394	25	A15 (1.350)	R12
696.223.394.99	5705499131536	400x1000	998	394	25	A15 (1.350)	R12

LADDER GRATING CHANNEL

25 MM HEIGHT

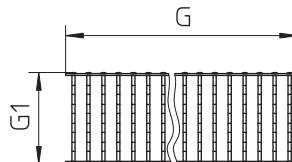
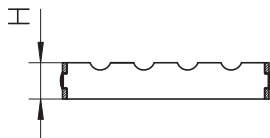

Type no.	EAN no.	Name	G	G1	H	EN1253 (kg)	EN1433 (kg)	Non slip
697.125.150.50	5705499103465	150x500	499	145	25	M125 (10.000)	A15 (5.000)	R11
697.125.200.50	5705499103502	200x500	499	195	25	R50 (7.000)	A15 (7.000)	R11
697.125.300.50	5705499103540	300x500	499	295	25	R50 (6.000)	A15 (7.000)	R11
697.125.400.50	5705499131574	400x500	499	395	25		A15 (7.000)	R11

Gratings

LADDER GRATING CHANNEL, NON-TILT

25 MM HEIGHT

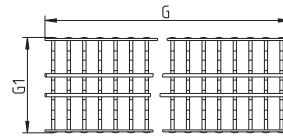
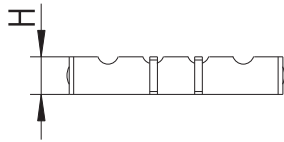

Type no.	EAN no.	Name	G	G1	H	EN1253 (kg)	EN1433 (kg)	Non slip
697.127.150.50	5705499128727	150x500	499	145	25	M125 (11.000)	A15 (5.000)	R11
697.127.200.50	5705499128734	200x500	499	195	25	M125 (8.333)	A15 (7.000)	R11

LADDER GRATING CHANNEL

8 MM MATERIAL, FULLY WELDED

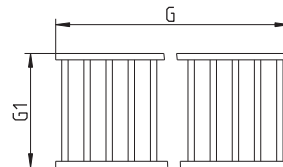
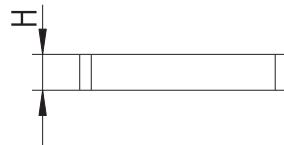

Type no.	EAN no.	Name	G	G1	H	EN1253 (kg)	EN1433 (kg)	Non slip
697.225.150.50	5705499128642	150x500	499	144	25	N250 (20.000)	B125 (10.000)	R11
697.225.200.50	5705499128659	200x500	499	194	25	N250 (20.000)	B125 (10.000)	R11
697.225.300.50	5705499128666	300x500	499	294	25	N250 (16.666)	B125 (12.000)	R11
697.225.400.50	5705499128673	400x500	499	394	25		B125 (12.000)	R11

HYGIENICPRO GRATING CHANNEL

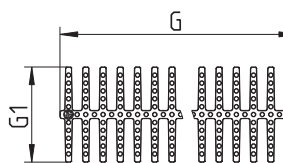
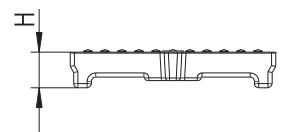

Type no.	EAN no.	Name	G	G1	H	EN1253 (kg)	EN1433 (kg)	Non slip
697.250.150.50	5705499117868	150x500	499	145	25	M125 (10.000)	A15 (6.000)	R10
697.250.200.50	5705499117967	200x500	499	195	25	M125 (10.000)	A15 (7.000)	R10
697.250.300.50	5705499133103	300x500	499	295	40	N250 (20.000)		R10

Only available in stainless steel grade AISI CF-8 corresponding to AISI 304C/EN1.4308

Gratings

HYGIENICPRO GRATING CHANNEL

ROUNDED IN ONE END

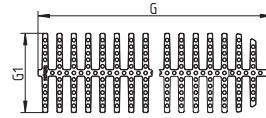

Type no.	EAN no.	Name	G	G1	H	EN1253 (kg)	EN1433 (kg)	Non slip
697.250.150.57	5705499137910	150x500	572	145	25	M125 (10.000)	A15 (6.000)	R10

Only available in stainless steel grade AISI CF-8 corresponding to AISI 304C/EN1.4308

TILED/EPOXY GRATING CHANNEL

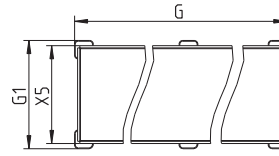
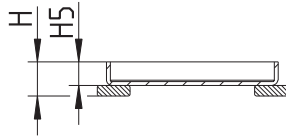

Type no.	EAN no.	Name	G	G1	H	H5	X5	EN1253 (kg)
697.020.150.49	5705499128574	150x500	499	145	26	18	131	K3 (900)
697.020.200.49	5705499128581	200x500	499	195	26	18	181	L15 (1.800)
697.020.300.49	5705499128598	300x500	499	295	26	18	281	K3 (600)

SHOWER GRATING CHANNEL

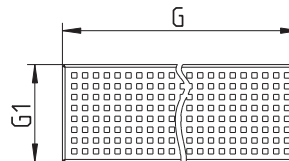
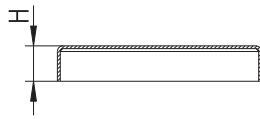

Type no.	EAN no.	Name	G	G1	H	EN1253 (kg)	Non slip
697.015.150.50	5705499103182	150x500	499	144	25	K3 (500)	R10
697.015.150.99	5705499117394	150x1000	998	144	25	K3 (500)	R10
697.015.200.50	5705499117424	200x500	499	194	25	K3 (400)	R10
697.015.200.99	5705499124538	200x1000	998	194	25	K3 (400)	R10

Gratings

SLOT GRATING SQUARE

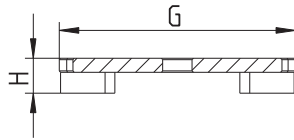

Type no.	EAN no.	Name	G	H	EN1253 (kg)	EN1433 (kg)	Non slip
790.168.000.10	5705499113440	200x200	170x170	25	R50 (5.000)		R10
790.218.000.10	5705499128710	250x250	220x220	25	R50 (5.000)	A15 (4.000)	R10
790.268.000.10	5705499113648	300x300	270x270	25	R50 (6.000)		R10

MESH GRATING SQUARE

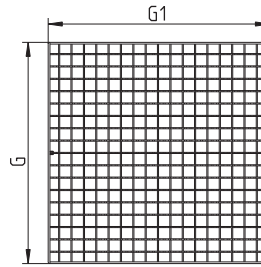
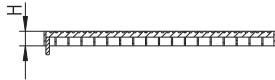

Type no.	EAN no.	Name	G	G1	H	EN1253 (kg)	Non slip
790.168.000.22	5705499113464	200x200	168x168		25	L15 (1.350)	R12
790.218.000.22	5705499128680	250x250	218x218		25	L15 (1.500)	R12
790.268.000.22	5705499113655	300x300	268x268		25	L15 (1.600)	R12
696.223.394.395	5705499117356	400x400	394x394		25	L15 (1.500)	R12
696.223.394.595	5705499126846	400x600	394	594	25	L15 (1.500)	R12
696.223.494.495	5705499117363	500x500	494x494		25	L15 (1.500)	R12
696.223.494.795	5705499126853	500x800	494	794	25	L15 (1.500)	R12
696.223.594.895	5705499126860	600x900	594	894	25	L15 (1.000)	R12

LADDER GRATING SQUARE

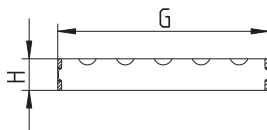
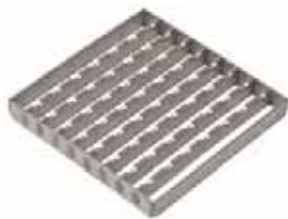

Type no.	EAN no.	Name	G	H	EN1253 (kg)	Non slip
790.168.000.25	5705499113488	200x200	168x168	25	R50 (5.000)	R11
790.218.000.25	5705499128703	250x250	218x218	25	R50 (4.000)	R11
790.268.000.25	5705499113679	300x300	268x268	40	M125 (10.000)	R11

Gratings

LADDER GRATING SQUARE

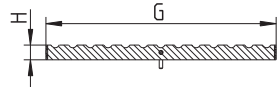
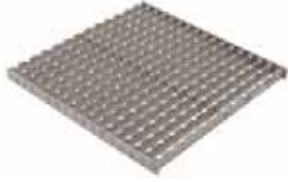

Type no.	EAN no.	Name	G	H	Non slip
697.125.400.395	5705499117752	400x400	395x395	25	R11
697.125.500.495	5705499117769	500x500	495x495	25	R11

LADDER GRATING SQUARE

8 MM MATERIAL, FULLY WELDED

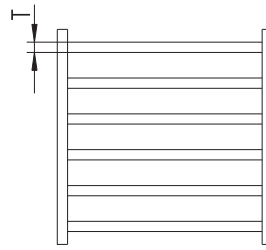
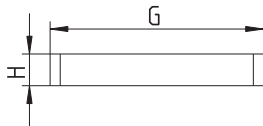

Type no.	EAN no.	Name	G	H	T	EN1253 (kg)	Non slip
790.168.000.28	5705499124163	200x200	168x168	25	8	M125 (12.000)	R11
790.218.000.28	5705499128604	250x250	218x218	25	8	R50 (6.000)	R11
790.268.000.28	5705499128611	300x300	268x268	25	8	R50 (7.000)	R11

HYGIENICPRO GRATING SQUARE

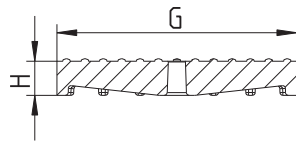

Type no.	EAN no.	Name	G	H	EN1253 (kg)	Non slip
790.168.000.60	5705499113495	200x200	170x170	24	R50 (7.000)	R10
790.218.000.60	5705499128338	250x250	220x220	24	R50 (5.000)	R10
790.268.000.60	5705499113686	300x300	270x270	24	R50 (5.000)	R10

Only available in stainless steel grade AISI CF-8 corresponding to AISI 304C/EN1.4308

Gratings

3MM GRATING SQUARE

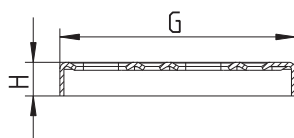

Type no.	EAN no.	Name	G	H	EN1253 (kg)	Non slip
790.168.000.03	5705499113433	200x200	168x168	24	L15 (1.750)	R10
790.218.000.03	5705499128697	250x250	218x218	24	L15 (1.500)	R10
790.268.000.03	5705499113631	300x300	268x268	24	L15 (1.250)	R10

TILED/EPOXY GRATING SQUARE

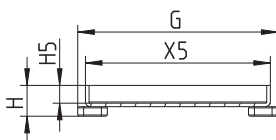

Type no.	EAN no.	Name	G	H	H5	X5	EN1253 (kg)
790.168.000.06	5705499128529	200x200	169x169	26	15	156	L15 (1.500)
790.218.000.06	5705499128536	250x250	219x219	26	15	206	L15 (1.000)
790.268.000.06	5705499128543	300x300	269x269	26	15	256	L15 (1.000)

SHOWER GRATING SQUARE

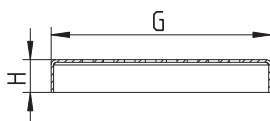

Type no.	EAN no.	Name	G	H	EN1253 (kg)	Non slip
790.168.000.04	5705499128420	200x200	168x168	25	K3 (800)	R10
790.218.000.04	5705499128444	250x250	218x218	25	K3 (700)	R10
790.268.000.04	5705499128451	300x300	268x268	25	K3 (600)	R10

Gratings

BLANK PLATE SQUARE

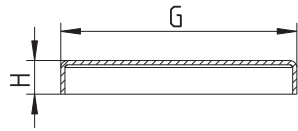

Type no.	EAN no.	Name	G	H	EN1253 (kg)
790.168.000.00	5705499121179	200x200	168x168	24	L15 (1.750)
790.268.000.00	5705499121186	300x300	268x268	24	L15 (1.500)

SLOT GRATING CIRCLE

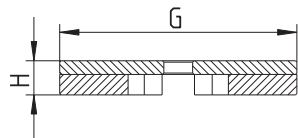

Type no.	EAN no.	Name	G	H	EN1253 (kg)	Non slip
790.273.000.10 S	5705499106862	Ø295	Ø273	25	M125 (8.333)	R10

MESH GRATING CIRCLE

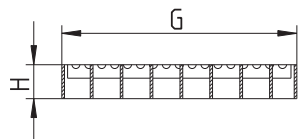

Type no.	EAN no.	Name	G	H	EN1253 (kg)	Non slip
790.273.000.22	5705499113792	Ø295	Ø273	25	L15 (1.000)	R12

Gratings

LADDER GRATING CIRCLE

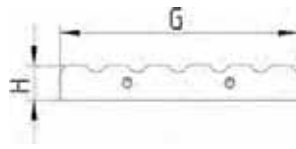

Type no.	EAN no.	Name	G	H	EN1253 (kg)	Non slip
790.273.000.25 S	5705499106879	Ø295	Ø273	25	R50 (3.333)	R11

LADDER GRATING CIRCLE

8 MM MATERIAL, FULLY WELDED

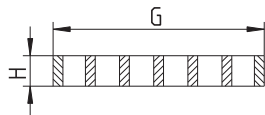

Type no.	EAN no.	Name	G	H	EN1253 (kg)	Non slip
790.273.000.28	5705499128635	Ø295	Ø273	25	M125 (10.000)	R11

HYGIENICPRO GRATING CIRCLE

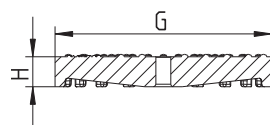

Type no.	EAN no.	Name	G	H	EN1253 (kg)	Non slip
790.273.000.60	5705499128352	Ø295	Ø273	24	R50 (5.000)	R10

Gratings

3MM GRATING CIRCLE

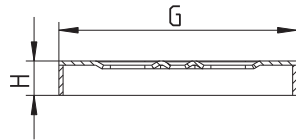

Type no.	EAN no.	Name	G	H	EN1253 (kg)	Non slip
790.273.000.03 S	5705499106855	Ø295	Ø273	25	L15 (1.000)	R10

TILED/EPOXY GRATING CIRCLE

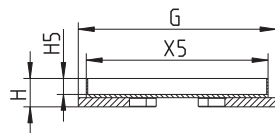

Type no.	EAN no.	Name	G	H	H5	X5	EN1253 (kg)
790.273.000.06	5705499128567	Ø295	Ø273	25	14	259	K3 (750)

BLANK PLATE CIRCLE

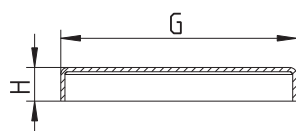

Type no.	EAN no.	Name	G	H	EN1253 (kg)
790.273.000.00	5705499121223	Ø295	Ø273	25	L15 (1.000)

HYGIENICPRO END PIECE FOR GRATING

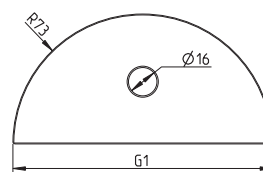
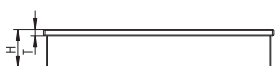

Type no.	EAN no.	G1	H	T	EN1253 (kg)
670.000.030 S	5705499138566	146	24	4	R50 (5.000)

Water traps

REMOVABLE TWO-PART WATER TRAP TYPE 502.050

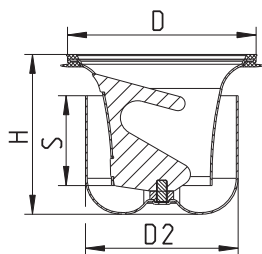

Type no.	EAN no.	D	H	S	D2	Max Flow (l/s)
502.050.110	5705499124064	108	89	50	85	1.7

Accurate flow rate depending on type of channel and grating.

REMOVABLE WATER TRAP TYPE 502.052

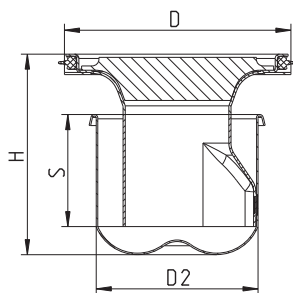

Type no.	EAN no.	D	H	S	D2	Max Flow (l/s)
502.052.110	5705499105582	108	93	52	75	1.3

Accurate flow rate depending on type of channel and grating.

REMOVABLE WATER TRAP TYPE 562.00

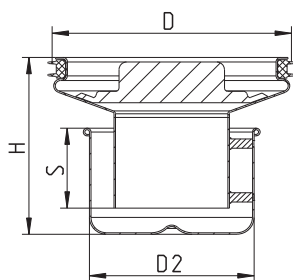

Type no.	EAN no.	D	H	S	D2	Max Flow (l/s)
562.002.000 S	5705499107968	157	115	52	107	3.3

Accurate flow rate depending on type of channel and grating.

Water traps

REMOVABLE TWO-PART WATER TRAP TYPE 562.10

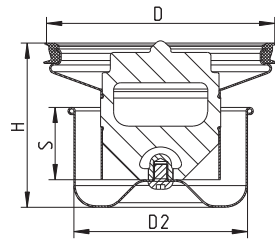

Type no.	EAN no.	D	H	S	D2	Min Flow (l/s)	Max Flow (l/s)
562.102.000 S	5705499137903	157	113	50	120	3.4	6.0
562.103.000 S	5705499138733	246	118	52	197	5.6	7.8

Accurate flow rate depending on type of channel and grating.

REMOVABLE WATER TRAP TYPE 503.001

PREVENTS SMELL

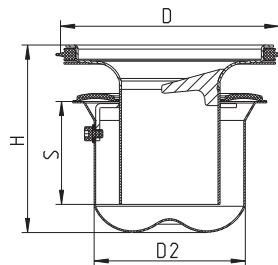

Type no.	EAN no.	D	H	S	D2	Max Flow (l/s)
503.001.110	5705499134728	108	93	51	75	1.3

Accurate flow rate depending on type of channel and grating.

REMOVABLE WATER TRAP TYPE 563.00

PREVENTS SMELL

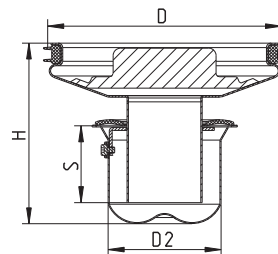

Type no.	EAN no.	D	H	S	D2	Max Flow (l/s)
563.002.000	5705499135275	157	120	51	75	1.3

Accurate flow rate depending on type of channel and grating.

Water traps

P-TRAP 87.5° TYPE 525.090

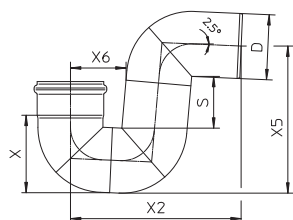

Type no.	EAN no.	D	S	X	X2	X5	X6	Min Flow (l/s)	Max Flow (l/s)
525.090.075 S	5705499101478	75	81	93	222	189	74	2.5	3.7
525.090.110 S	5705499101485	110	89	132	289	249	94	3.4	10.4
525.090.160 S	5705499101492	160	105	187	388	338	121	7.5	28.5

Accurate flow rate depending on type of channel and grating.

Others

FILTER BASKET TYPE 780

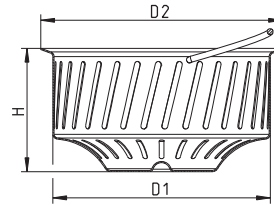
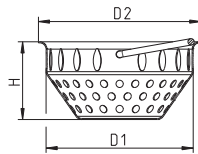

Type no.	EAN no.	D1	H	D2	Volume (l)
780.002.000.05	5705499113358	140	74	155	0.9
780.004.020.05	5705499137941	220	125	245	3.9

If the drain is to be fitted with both filter basket and water trap, make sure that the height of the drain is sufficient.

FILTER BASKET, LOW MODEL TYPE 780

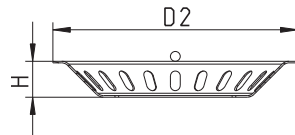

Type no.	EAN no.	H	D2	Volume (l)
780.002.001.05	5705499113372	22	150	0.2
780.004.010.05	5705499137934	41	245	0.8

FILTER BASKET, HIGH MODEL TYPE 780

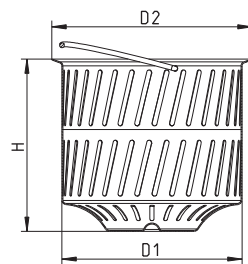

Type no.	EAN no.	D1	H	D2	Volume (l)
780.004.030.05	5705499137958	220	210	245	7.1

If the drain is to be fitted with both filter basket and water trap, make sure that the height of the drain is sufficient.

Others

FILTER BASKET TYPE 780

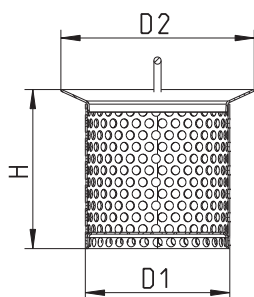

Type no.	EAN no.	D1	H	D2
780.107.110.05 S	5705499104486	80	88	107

Only for use in drains without removable water trap

FILTER BASKET, WITHOUT BOTTOM SLOT TYPE 780

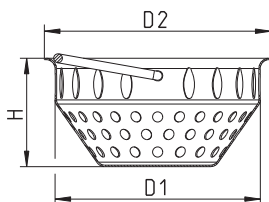

Type no.	EAN no.	D1	H	D2
780.002.004.05	5705499128499	140	74	155

If the drain is to be fitted with both filter basket and water trap, make sure that the height of the drain is sufficient.

FILTER BASKET TYPE 780

WITH 6 MM HOLES

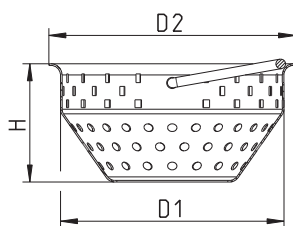

Type no.	EAN no.	D1	H	D2
780.002.003.05	5705499119909	140	74	155

If the drain is to be fitted with both filter basket and water trap, make sure that the height of the drain is sufficient.

Others

HYGIENICPRO FILTER FOR CHANNEL TYPE 780

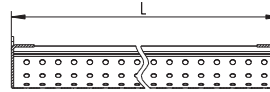
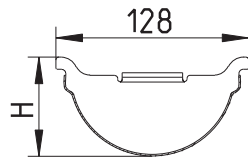

Type no.	EAN no.	H	L
780.005.150.05	5705499137927	66	499

FILTER BASKET FOR TWO-PART WATER TRAP

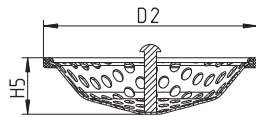

Type no.	EAN no.	H5	D2
502.000.000 S	5705499124101	24	106

SAND BUCKET TYPE 780

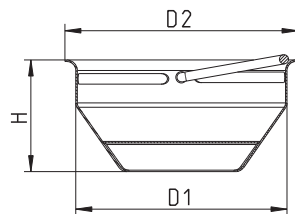

Type no.	EAN no.	D1	H	D2
780.002.000.00	5705499113334	140	74	155
780.004.020.00	5705499138764	220	125	245

If the drain is to be fitted with both sand bucket and water trap, make sure that the height of the drain is sufficient.

OUTLET FILTER

FOR CHANNELS WITH VERTICAL OUTLET

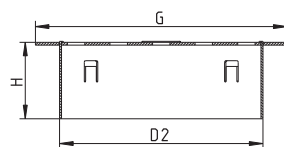

Type no.	EAN no.	G	H	D2
780.400.075.05	5705499135305	Ø95	40	70
780.400.110.05	5705499135251	Ø130	40	105
780.400.160.05	5705499135480	Ø180	40	155

Others

PLUG FOR CHANNEL AND KITCHEN CHANNEL

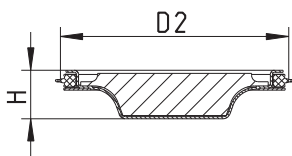

Type no.	EAN no.	H	D2
620.300.019 S	5705499118568	23	108
700.000.004 S	5705499118575	36	157
700.000.250 S	5705499138818	27	246

SEALING RING FOR WATER TRAP TYPE 502.050.110

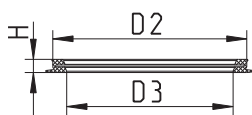

Type no.	EAN no.	H	D2	D3	Material
620.300.042	5705499127331	7	102	87	EPDM
620.300.042 N	5705499138993	7	102	87	NBR

SEALING RING FOR WATER TRAP TYPE 562.00

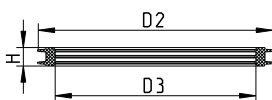

Type no.	EAN no.	H	D2	D3	Material
562.002.EPDM	5705499108002	12	154	131	EPDM
562.003.EPDM	5705499108071	12	249	225	EPDM

SEALING RING FOR WATER TRAP TYPE 562.10

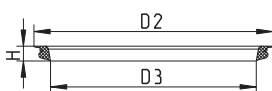

Type no.	EAN no.	H	D2	D3	Material
562.103.EPDM	5705499138740	16	260	223	EPDM
562.103.NBR	5705499138757	16	260	223	NBR

Others

SEALING RING FOR LOWER PART

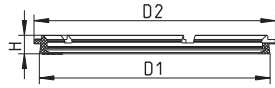

Type no.	EAN no.	Designation.	D1	H	D2	Material
700.002.EPDM	5705499108101	Fits all lower parts type XXX.002.XXX	189	22	208	EPDM
700.003.EPDM	5705499108118	Fits all lower parts type XXX.003.XXX	275	22	287	EPDM

MEMBRANE CLAMPING FLANGE FOR LOWER PART TYPE 325

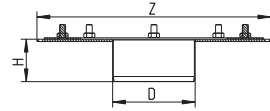

Type no.	EAN no.	D	Z	H
325.302.000	5705499107920	113	Ø320	58

FLANGE FOR LOWER PART TYPE 326

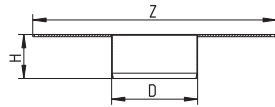

Type no.	EAN no.	D	Z	H
326.302.000	5705499107944	113	Ø320	58

INTERMEDIATE SECTION WITH MEMBRANE FLANGE TYPE 777

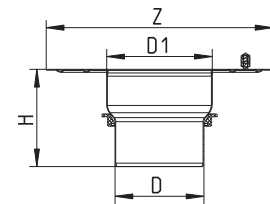

Type no.	EAN no.	D	D1	Z	H
777.002.000	5705499112931	160	190	Ø409	190
777.003.000	5705499112955	250	272	Ø507	196

Others

INTERMEDIATE SECTION WITH CLAMPING FLANGE TYPE 779

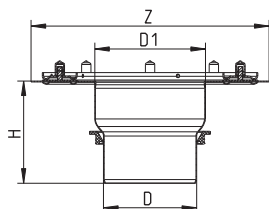

Type no.	EAN no.	D	D1	Z	H
779.002.000	5705499113136	160	190	Ø409	190
779.003.000	5705499113150	250	272	Ø507	196

ADJUSTABLE LEGS

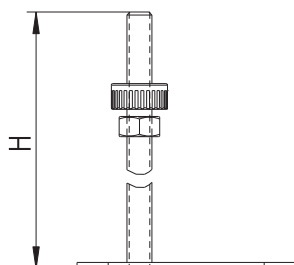

Type no.	EAN no.	H
670.000.001	5705499116243	150
670.000.005	5705499131741	300

GRATING LOCK

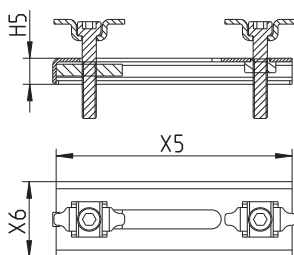

Type no.	EAN no.	H5	X5	X6
670.000.003 S	5705499120493	11	100	32

For gratings with height max 25mm.
Used for locking the grating / grating combination.

Others

GRATING LOCK

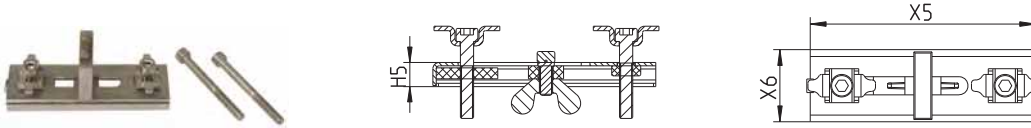

Type no.	EAN no.	H5	X5	X6
670.000.004 S	5705499128512	11	100	32

Used for locking the grating / cross-bar / grating combination.

MOUNTING BRACKET FOR CHANNELS

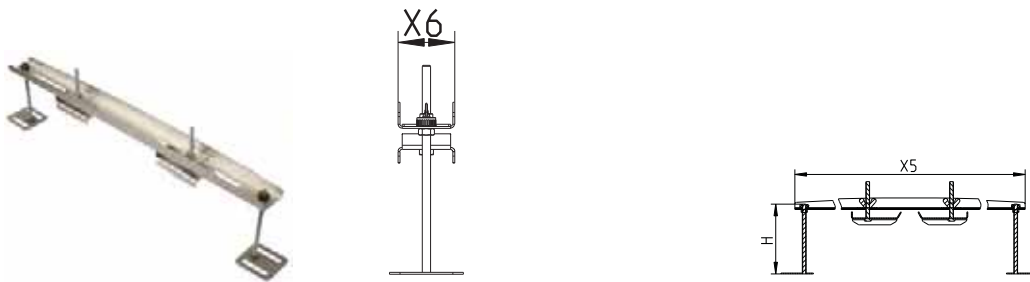

Type no.	EAN no.	H	X5	X6
670.000.000	5705499129342	150	680	54

HYGIENICPRO SPACING RING FOR FILTER BASKET

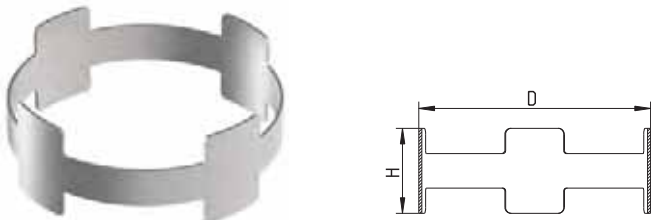

Type no.	EAN no.	D	H
670.000.010	5705499137972	155	57

For medium or high filter basket used together with a P-trap.

HYGIENICPRO TILE ADAPTOR FOR CHANNEL

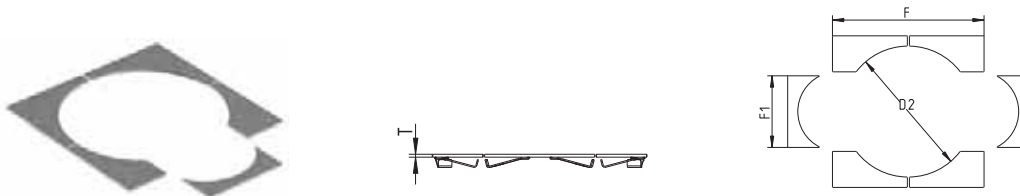

Type no.	EAN no.	Designation.	F	F1	D2	T
670.000.020	5705499137989	End outlet	375	192	325	5
670.000.021	5705499137996	Center outlet	375	192	325	5

For channels mounted in the tiles.

Others

FUNNEL FOR GRATING

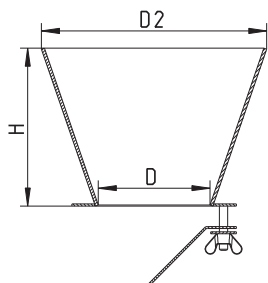

Type no.	EAN no.	D	H	D2
670.005.000	5705499137965	109	153	219

HYGIENIC CLEAN



Type no.	EAN no.
800.000.150	5705499138863

For cleaning of HygienicPro channels.

FRAME GUARD

FOR CHANNELS

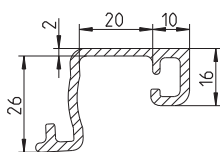

Type no.	EAN no.	L
670.000.006	5705499138542	2000

Others

VINYL HOLE PUNCHING TOOL

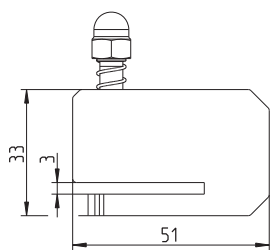

Type no.	EAN no.
001.200.002	5705499128239

Channel type numbers

6XX AA XXX-XX A A S

Example: 670CH010-00BA S (670 CH 010-00 B A S)

Material grade

(blank) Stainless steel AISI 304
S Stainless steel AISI 316L

Option

A None
B Edge infill
C Protective strip on frame
D Edge infill and protective strip on frame

Variant

A Stabiliser angle
B Anchor tangs

Outlet position

00 End
05 Center in 1 m channel
++ Etc. - outlet always placed in end or center

Length

010 Etc. - Channel length, e.g. 010 = 1 m, 060 = 6 m

Outlet dimension

H Ø110 mm (DN 100)
K Ø160 mm (DN 150)
N Ø50 mm

Width

A Slot channel
C 150 mm
D 200 mm
E 300 mm
F 400 mm

Type

670 Channel without outlet box for concrete, tiled and resin floors
671 Channel with outlet box for concrete, tiled and resin floors
672 Channel without outlet box for vinyl floors
673 20 mm slot channel with outlet box for concrete, tiled and resin floors
674 Channel without outlet box, with 50 mm liquid membrane flange, for concrete, tiled and resin floors
676 HygienicPro® channel for concrete, tiled and resin floors
677 8 mm slot channel without outlet box, with 50 mm liquid membrane flange, for concrete, tiled and resin floors
678 Channel with 84 mm liquid membrane flange, for concrete, tiled and resin floors

Kitchen channel type numbers

XXX AA XXX-XX S Example: 660FK008-11 (660 F K 008-11)

Material grade

(blank) Stainless steel AISI 304
S Stainless steel AISI 316L

Height

00 Industrial upper part
06 60 mm
11 110 mm
15 150 mm

Length

001 250 mm (250x250 mm upper part)
002 200 mm (200x200 mm upper part)
003 300 mm (300x300 mm upper part)
004 400 mm
005 500 mm
006 600 mm
008 800 mm
100 1000 mm

Outlet dimension

H Ø110 mm
K Ø160 mm

Width

C 250 (250x250 mm upper part)
D 200 (200x200 mm upper part)
E 300 (300x300 mm upper part)
F 400
G 500

Type

660 Kitchen channel for concrete, tiled and resin floor
662 Kitchen channel for vinyl floors
664 Kitchen channel, with 50 mm liquid membrane flange, for concrete, tiled and resin floor
668 Kitchen channel, with 100 mm liquid membrane flange, for concrete, tiled and resin floor

Total installation heights for channels

BLÜCHER® Channel
Total installation heights (minimum and maximum)

		Channels												
		Type 670		Type 671		Type 673			Type 674		Type 678	Type 672		
Lower parts		H5 = 90	H5 = 120	H6 = 100	H6 = 125	H6 = 85	H6 = 100	H6 = 120	H5 = 90	H5 = 120	100 ≤ H5 ≤ 118	H5 = 90	H5 = 120	
Channel outlet	Ø110mm		193-238	223-268	---	---	---	---	---	193-238	223-268	203-266	193-238	223-268
			160-205	190-235	---	---	---	---	---	160-205	190-235	170-233	160-205	190-235
			193-238	223-268	---	---	---	---	---	193-238	223-268	203-266	193-238	223-268
			148-193	178-223	---	---	---	---	---	148-193	178-223	158-221	148-193	178-223
			214-259	244-289	---	---	---	---	---	214-259	244-289	224-287	214-259	244-289
			161-206	191-236	---	---	---	---	---	161-206	191-236	171-234	161-206	191-236
	Ø160mm		267-312	297-342	---	---	---	---	---	267-312	297-342	277-340	267-312	297-342
			263-308	293-338	---	---	---	---	---	263-308	293-338	273-336	263-308	293-338
			231-276	261-306	---	---	---	---	---	231-276	261-306	241-304	231-276	261-306
			362-422	392-452	372-432	397-457	357-417	372-432	392-452	362-422	392-452	---	362-422	392-452
			373-433	403-463	383-443	408-468	368-428	383-443	403-463	373-433	403-463	---	373-433	403-463
			312-372	342-402	322-382	347-407	307-367	322-382	342-402	312-372	342-402	---	312-372	342-402
		279-339	309-369	289-349	314-374	274-334	289-349	309-369	279-339	309-369	---	279-339	309-369	
		312-372	342-402	322-382	347-407	307-367	322-382	342-402	312-372	342-402	---	312-372	342-402	
		260-320	290-350	270-330	295-355	255-315	270-330	290-350	260-320	290-350	---	260-320	290-350	
		261-301	291-331	271-311	296-336	256-296	271-311	291-331	261-301	291-331	---	261-301	291-331	
		209-249	239-279	219-259	244-284	204-244	219-259	239-279	209-249	239-279	---	209-249	239-279	
		360-400	390-430	370-410	395-435	355-395	370-410	390-430	360-400	390-430	---	360-400	390-430	
		362-422	392-452	372-432	397-457	357-417	372-432	392-452	362-422	392-452	---	362-422	392-452	
		373-433	403-463	383-443	408-468	368-428	383-443	403-463	373-433	403-463	---	373-433	403-463	
		312-372	342-402	322-382	347-407	307-367	322-382	342-402	312-372	342-402	---	312-372	342-402	
		279-339	309-369	289-349	314-374	274-334	289-349	309-369	279-339	309-369	---	279-339	309-369	
		312-372	342-402	322-382	347-407	307-367	322-382	342-402	312-372	342-402	---	312-372	342-402	
		260-320	290-350	270-330	295-355	255-315	270-330	290-350	260-320	290-350	---	260-320	290-350	
	362-422	392-452	372-432	397-457	357-417	372-432	392-452	362-422	392-452	---	362-422	392-452		
	373-433	403-463	383-443	408-468	368-428	383-443	403-463	373-433	403-463	---	373-433	403-463		
	312-372	342-402	322-382	347-407	307-367	322-382	342-402	312-372	342-402	---	312-372	342-402		
	279-339	309-369	289-349	314-374	274-334	289-349	309-369	279-339	309-369	---	279-339	309-369		
	312-372	342-402	322-382	347-407	307-367	322-382	342-402	312-372	342-402	---	312-372	342-402		
	260-320	290-350	270-330	295-355	255-315	270-330	290-350	260-320	290-350	---	260-320	290-350		

Table shows total installation heights from frame top to lowest point on lower part
Dimensions in gray cells are height from frame top to centre of outlet

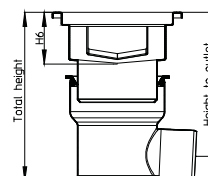
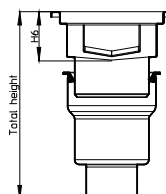
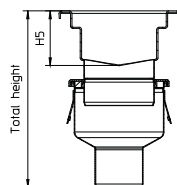

Total installation heights for kitchen channels

BLÜCHER® Channel

Kitchen channels - Total installation heights (minimum and maximum)

		Kitchen Channels											
		Type 660			Type 662			Type 664			Type 668		
Lower parts		H5 = 60	H5 = 110	H5 = 150	H5 = 60	H5 = 110	H5 = 150	H5 = 60	H5 = 110	H5 = 150	94 ≤ H5 ≤ 112		
Channel outlet	Ø110mm	110.000.050	163-208	213-258	253-298	163-208	213-258	253-298	163-208	213-258	253-298	---	
		110.000.075	130-175	180-225	220-265	130-175	180-225	220-265	130-175	180-225	220-265	---	
		110.000.110	163-208	213-258	253-298	163-208	213-258	253-298	163-208	213-258	253-298	---	
		110.000.110	118-163	168-213	208-253	118-163	168-213	208-253	118-163	168-213	208-253	---	
		150.000.050	184-229	234-279	274-319	184-229	234-279	274-319	184-229	234-279	274-319	---	
		150.000.075	131-176	181-226	221-266	131-176	181-226	221-266	131-176	181-226	221-266	---	
	Channel outlet	Ø160mm	150.000.110	237-282	287-332	327-372	237-282	287-332	327-372	237-282	287-332	327-372	---
			150.000.075	233-278	283-328	323-368	233-278	283-328	323-368	233-278	283-328	323-368	---
			150.000.110	201-246	251-296	291-336	201-246	251-296	291-336	201-246	251-296	291-336	---
			760.002.075	332-392	382-442	422-482	332-392	382-442	422-482	332-392	382-442	422-482	366-444
			760.002.110	343-403	393-453	433-493	343-403	393-453	433-493	343-403	393-453	433-493	377-455
			763.002.075	282-342	332-392	372-432	282-342	332-392	372-432	282-342	332-392	372-432	316-394
Ø110mm		763.002.110	249-309	299-359	339-399	249-309	299-359	339-399	249-309	299-359	339-399	283-361	
		763.002.110	282-342	332-392	372-432	282-342	332-392	372-432	282-342	332-392	372-432	316-394	
		763.042.110	230-290	280-340	320-380	230-290	280-340	320-380	230-290	280-340	320-380	264-342	
		760.160.110	243-283	293-333	333-373	243-283	293-333	333-373	243-283	293-333	333-373	277-335	
		760.160.110	191-231	241-281	281-321	191-231	241-281	281-321	191-231	241-281	281-321	225-283	
		760.160.110	330-370	380-420	420-460	330-370	380-420	420-460	330-370	380-420	420-460	368-426	
Ø160mm		774.002.075	332-392	382-442	422-482	332-392	382-442	422-482	332-392	382-442	422-482	366-444	
		774.002.110	343-403	393-453	433-493	343-403	393-453	433-493	343-403	393-453	433-493	377-455	
		769.002.075	282-342	332-392	372-432	282-342	332-392	372-432	282-342	332-392	372-432	316-394	
		769.002.110	249-309	299-359	339-399	249-309	299-359	339-399	249-309	299-359	339-399	283-361	
		769.002.110	282-342	332-392	372-432	282-342	332-392	372-432	282-342	332-392	372-432	316-394	
		775.002.075	230-290	280-340	320-380	230-290	280-340	320-380	230-290	280-340	320-380	264-342	
Ø160mm	775.002.075	332-392	382-442	422-482	332-392	382-442	422-482	332-392	382-442	422-482	366-444		
	775.002.110	343-403	393-453	433-493	343-403	393-453	433-493	343-403	393-453	433-493	377-455		
	771.002.075	282-342	332-392	372-432	282-342	332-392	372-432	282-342	332-392	372-432	316-394		
	771.002.110	249-309	299-359	339-399	249-309	299-359	339-399	249-309	299-359	339-399	283-361		
	771.002.110	282-342	332-392	372-432	282-342	332-392	372-432	282-342	332-392	372-432	316-394		
	771.002.110	230-290	280-340	320-380	230-290	280-340	320-380	230-290	280-340	320-380	264-342		

Table shows total installation heights from frame top to lowest point on lower part

Dimensions in gray cells are height from frame top to centre of outlet

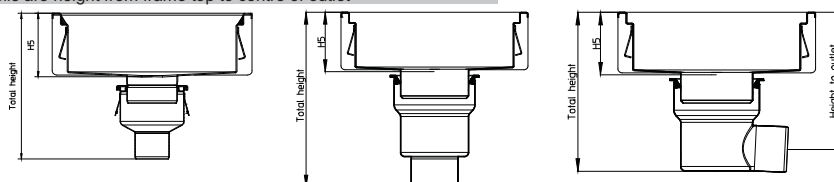













Load classes

Gratings and Access Covers

BLÜCHER **GRATINGS FOR INDOOR USE** are tested and classified according to EN 1253 "Gullies for buildings"

BLÜCHER **GRATINGS FOR OUTDOOR USE** are tested and classified in accordance with EN 1433 "Drainage channels for vehicular and pedestrian areas".

BLÜCHER **ACCESS COVERS** are tested and classified in accordance with EN 124 "Gully tops and manhole tops for vehicular and pedestrian areas".

	H 1,5	(150 kg)	No load areas				
	K 3	(300 kg)	Barefoot areas				
	L 15	(1.500 kg)	Pedestrian and light traffic		A 15	(1.500 kg)	Pedestrian and light traffic
	R 50	(5.000 kg)	Light traffic and light industrial areas				
	M 125	(12.500 kg)	Traffic and industrial areas		B 125	(12.500 kg)	Car parking areas
	N 250	(25.000 kg)	Heavy traffic and heavy industrial areas		C 250	(25.000 kg)	Along roads
	P 400	(40.000 kg)	Extra heavy traffic and industrial areas		D 400	(40.000 kg)	Light industrial areas
					E 600	(60.000 kg)	Heavy traffic and industrial areas
					F 900	(90.000 kg)	Airports, container and industrial areas

Non-slip gratings

Gratings are non-slip tested according to DIN 51130

BLÜCHER® EuroPipe

BLÜCHER® Channel

BLÜCHER® Drain

BLÜCHER®

A **WATTS** Brand

T: +45 99 92 08 00 • export@blucher.com • blucher.com

© 2018 blucher.com